

# ..ideus

STRÜHM  
HOROZ

Oświetlenie 2017  
Katalog produktów

Osvětlení 2017  
Katalog výrobků

Osvetlenie 2017  
Katalóg výrobkov



# Objaśnienia symboli i oznaczeń

**CZ:** Vysvětlení symbolů a znaků / **SK:** Vysvetlenie symbolov a znakov

	PL: w komplecie / CZ: dodávky / SK: dodávky		GU10		PL: włącznik / CZ: spínač / SK: spínač
	PL: wymiary otworu montażowego / CZ: rozmery montážního otvoru / SK: rozmery montážneho otvoru		GU5.3		PL: możliwość regulacji kierunku świecenia / CZ: svítidlo nastavitelné / SK: svetidlo nastaviteľné
	PL: materiał / CZ: materiál / SK: materiál		PL: dedykowane źródło światła / CZ: určený zdroj světla / SK: určený svetelný zdroj		PL: czujnik ruchu / CZ: pohybové čidlo / SK: pohybové čidlo
	PL: uwagi / CZ: komentáře / SK: komentáře		SMD LED		PL: regulacja czujnika / CZ: nastavenie snímača / SK: nastavení čidla
	PL: zdjęcie produktu / CZ: fotografie produktu / SK: fotografie produktu		COB LED		PL: IP - stopień odporności na wnikanie ciał stałych i wilgoci / CZ: IP - stupeň krytí / SK: IP - stupeň krytia
	PL: kod Ideus / CZ: kód Ideus / SK: kód Ideus		POWER LED		PL: do zastosowania wewnątrz / CZ: k vnitřnímu použití / SK: k vnútornému použitiu
	PL: nazwa produktu / CZ: název výrobku / SK: názov výrobku		COG LED		PL: do zastosowania na zewnątrz lub wewnątrz / CZ: k venkovnímu nebo vnitřnímu použití / SK: k vonkajšiemu alebo vnútornému použitiu
	PL: kod kreskowy EAN / CZ: čárový kód EAN / SK: čiarový kód EAN		DIP LED		PL: minimalna odległość od oświetlanego obiektu / CZ: minimální vzdálenost od osvětlovaného předmětu / SK: minimálna vzdialenosť od osvetľovaného predmetu
	PL: zasilanie / CZ: napájení / SK: napájanie		G9		PL: klasa ochronności przed porażeniem elektrycznym / CZ: třída ochrany před úrazem elektrickým proudem / SK: trieda ochrany pred úrazom elektrickým prúdom
	PL: moc / CZ: výkon / SK: výkon		JC		PL: pierwsza / CZ: první / SK: prvý
	PL: strumień świetlny / CZ: světelný tok / SK: svetelný tok		GU10		PL: druga / CZ: druhá / SK: druhá
	PL: kolor / CZ: barva / SK: farba		MR16		PL: trzecia / CZ: třetí / SK: třetí
	PL: barwa światła / CZ: barva světla / SK: farba svetla		T5 / T8		PL: zgodność z normami europejskimi CE / CZ: shoda s evropskými normami CE / SK: zhoda s európskými normami CE
	PL: temperatura barowa Tc / CZ: teplota chromatičnosti Tc		PL		PL: marka produktu STRÜHM® / CZ: značka produktu STRÜHM® / SK: značka produktu STRÜHM®
	PL: dopuszczalne odchylenie barwy / CZ: přípustná odchylka barvy / SK: přípustná odchylka farby		PL: świetlówka/LED / CZ: úsporná zářivka/LED / SK: úsporná žiarivka/LED		PL: marka produktu HOROZ® / CZ: značka produktu HOROZ® / SK: značka produktu HOROZ®
	PL: rodzaj trzonka / CZ: patice / SK: pätica		PL: niewymienne źródło światła / CZ: nevyměnitelný světelný zdroj / SK: nevymeniteľný svetelný zdroj		
			PL: możliwość stosowania ze ściemniaczem / CZ: vhodné pro použití se stmívačem / SK: vhodné pre použitie so stmievačem		
			PL: nie stosować ze ściemniaczem / CZ: nepoužívejte stmívače / SK: nepoužívajte stmievača		
			PL: kąt rozsyłu światłości / CZ: vyzařovací úhel / SK: vyžarovací uhol		
			PL: współczynnik oddawania barw Ra / CZ: index reprodukce barev Ra / SK: Index reprodukcie farieb Ra		
			PL: trwałość źródła światła / CZ: żywotnost světelného zdroje / SK: životnosť svetelného zdroja		

## Karta katalogowa

**CZ:** Katalógový list / **SK:** Katalógový list

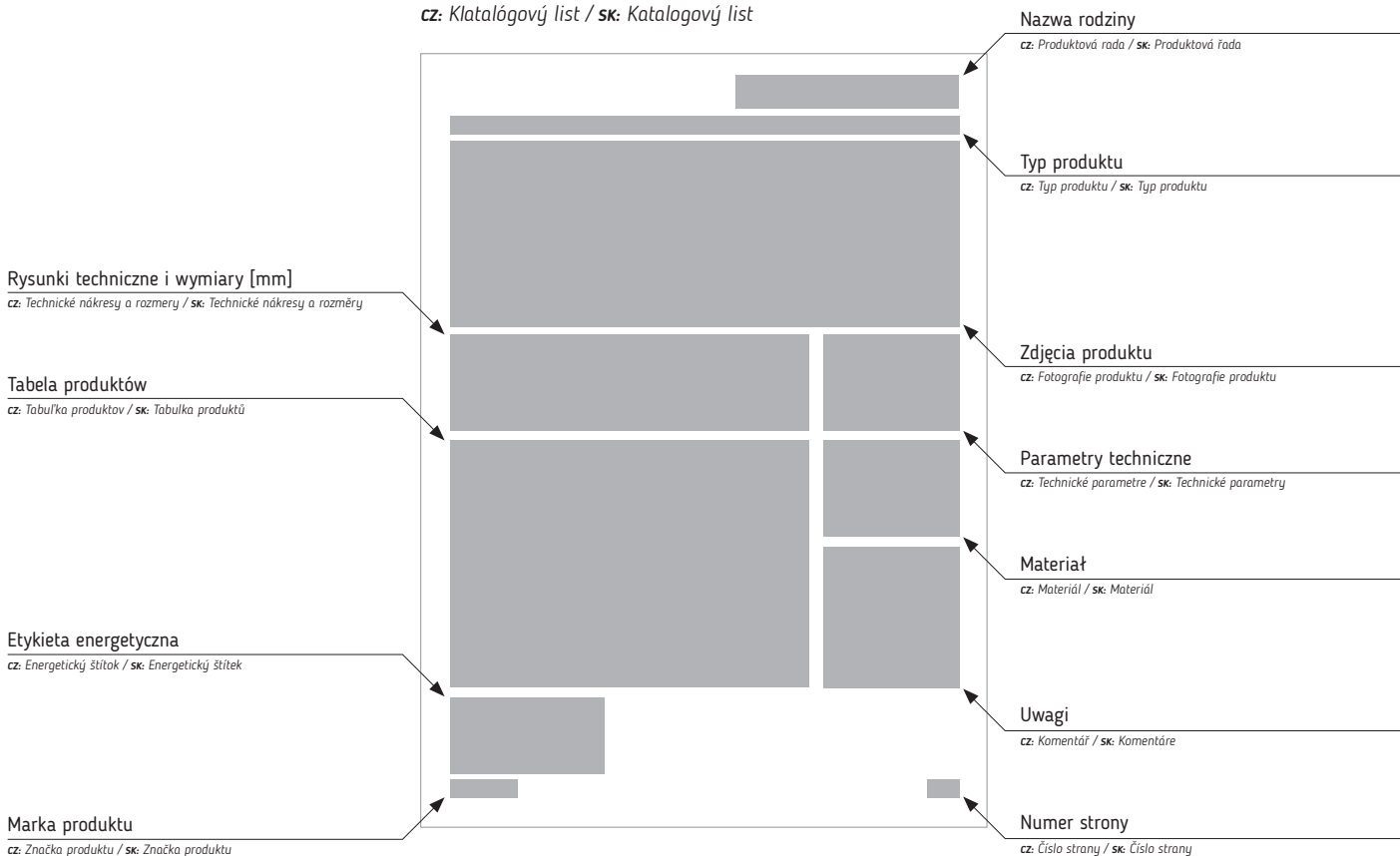





















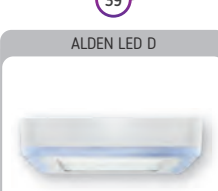

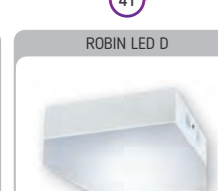

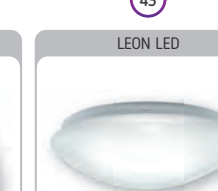







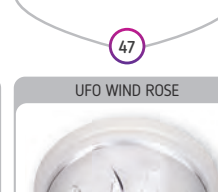

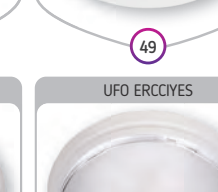



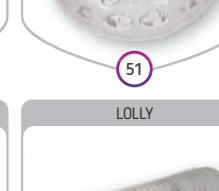
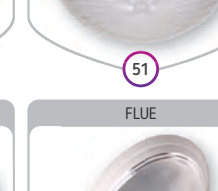

# Indeks obrazkowy

cz: Obrázkový index / sk: Obrázkový index

ANGELA HL761L  36	KAMI LED C  37	KAMI LED D  37	RAFI LED C  38	RAFI LED D  38	KRISTAL LED  39
GOLD LED  39	ROLEN LED  40	GUSTI LED  41	IGOR LED C  42	IGOR LED D  42	ALDEN LED C  43
ALDEN LED D  43	ROBIN LED C  44	ROBIN LED D  44	MARTIN LED C  45	MARTIN LED D  45	LEON LED  46
SOLA LED  46	LEON LED S  47	SOLA LED S  47	TINA SENSORLU LED  48	SENSORLU 360  48	ATMA  49
ILGAZ-1 HL634  50	KONAK-1 HL635  50	UFO WIND ROSE  51	UFO NAZAR  51	UFO ZAGREP  51	UFO ERCCIYES  51
UFO STAR  51	GLOP WIND ROSE  52	GLOP FAVORI  52	LOLLY  53	FLUE  54	NINOVA  54
SQUARE CLASSIC  55	SQUARE MODERN  55	BIG UFO BULUT  56	BIG UFO ZAGREP  56	BIG SQUARE CLASSIC  57	BIG SQUARE MODERN  57



















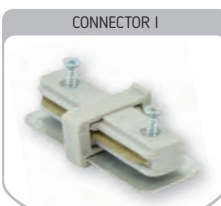





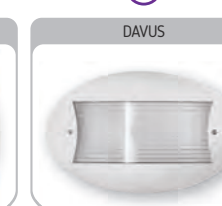

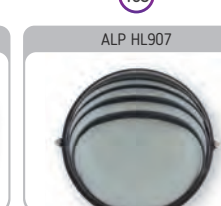

<p>FLAMINGO-4 HL6641L</p>  <p>58</p>	<p>BRENA LED 4W</p>  <p>58</p>	<p>FLAMINGO-6 HL6642L</p>  <p>58</p>	<p>BRENA LED 6W</p>  <p>58</p>	<p>PELIKAN HL6631L</p>  <p>58</p>	<p>ALBATROS-4 HL6651L</p>  <p>59</p>
<p>RITON LED 4W</p>  <p>59</p>	<p>ALBATROS-6 HL6652L</p>  <p>59</p>	<p>RITON LED 6W</p>  <p>59</p>	<p>NADIA G9</p>  <p>60</p>	<p>AMELIA LED</p>  <p>61</p>	<p>GABI LED 1D</p>  <p>62</p>
<p>GABI LED 2L</p>  <p>62</p>	<p>ZUZA LED 1L</p>  <p>62</p>	<p>ZUZA LED 2L</p>  <p>62</p>	<p>BETI LED C</p>  <p>63</p>	<p>BETI LED L</p>  <p>63</p>	<p>ERDEK HL855L</p>  <p>64</p>
<p>AVANOS HL857L</p>  <p>64</p>	<p>KUGU LORI LED 1V</p>  <p>65</p>	<p>TURNA LORI LED 1U</p>  <p>65</p>	<p>FLORYA-3 LED</p>  <p>65</p>	<p>FLORYA-6 LED</p>  <p>65</p>	<p>KENT LED 1D - 4D</p>  <p>66</p>
<p>LIKYA LED-1 - LED-5</p>  <p>67</p>	<p>DONAT LED 1C - 4L</p>  <p>68</p>	<p>NELI LED 1L - 3C</p>  <p>69</p>	<p>RUDA LED 1C - 4I</p>  <p>70</p>	<p>PARIS G9 1D - 2L</p>  <p>71</p>	<p>KRISTIN G9 1D - 4D</p>  <p>72</p>
<p>EPOS G9 1D - 4L</p>  <p>73</p>	<p>KEMER HL715 - HL719</p>  <p>74</p>	<p>KOMBI GU10 1C - 4D</p>  <p>75</p>	<p>MANAVGAT HL790N - HL794N</p>  <p>76</p>	<p>BODRUM HL785N - HL788N</p>  <p>77</p>	<p>DORI LED</p>  <p>78</p>
<p>DORI LED CLIP</p>  <p>78</p>	<p>RONI LED</p>  <p>79</p>	<p>RONI LED CLIP</p>  <p>79</p>	<p>IREM LED</p>  <p>80</p>	<p>TOLA E27</p>  <p>81</p>	<p>TOLA E27 CLIP</p>  <p>81</p>

# Indeks obrazkowy

cz: Obrázkový index / sk: Obrázkový index

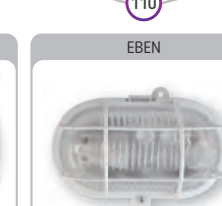
<p>KATI E27</p> <p>82</p>	<p>KATI E27 CLIP</p> <p>82</p>	<p>KITTY HL036</p> <p>83</p>	<p>MOLLY HL037</p> <p>84</p>	<p>DONALD HL043</p> <p>85</p>	<p>DEO LED 1W</p> <p>86</p>
<p>MYS LED 0,5W</p> <p>86</p>	<p>EGO LED 0,5W</p> <p>86</p>	<p>SIMPSON HL981L</p> <p>86</p>	<p>DORA HL990L WIEZA</p> <p>87</p>	<p>REX HL991L SLONCE</p> <p>87</p>	<p>BUGS HL992L SERCE</p> <p>87</p>
<p>MAX HL993L ROZA</p> <p>87</p>	<p>DUFFY HL994L MOTYL</p> <p>87</p>	<p>PUSKAS-1 HL331L</p> <p>88</p>	<p>PUSKAS-2 HL332L</p> <p>88</p>	<p>PUSKAS-3 HL333L</p> <p>88</p>	<p>CAFU-2 HL339L</p> <p>88</p>
<p>PELE-1 HL3094L</p> <p>88</p>	<p>PELE-2 HL3097L</p> <p>88</p>	<p>BECKHAM-1 HL341L</p> <p>88</p>	<p>WARTE 60</p> <p>89</p>	<p>ZICO-6 HL312L</p> <p>90</p>	<p>ZICO-4 HL313L</p> <p>90</p>
<p>SIGMA HL2001L</p> <p>91</p>	<p>ALFA HL2001</p> <p>92</p>	<p>LATE LED 3m IP20</p> <p>93</p>	<p>LATE LED 3m IP65</p> <p>93</p>	<p>LATE LED 5m IP20</p> <p>93</p>	<p>LATE LED 5m IP65</p> <p>93</p>
<p>LATE LED 3m BLISTER IP20</p> <p>94</p>	<p>LATE LED 3m BLISTER IP65</p> <p>94</p>	<p>LATE LED 5m BLISTER IP20</p> <p>94</p>	<p>LATE LED 5m BLISTER IP65</p> <p>94</p>	<p>DELTA HL160 - HL161</p> <p>95</p>	<p>PUNTO HL162 - HL163</p> <p>95</p>
<p>FLAT LED</p> <p>96</p>	<p>FLATER LED</p> <p>97</p>	<p>HL182L</p> <p>98</p>	<p>GALAKSI HL562L</p> <p>98</p>	<p>TURKUAZ HL564L</p> <p>98</p>	<p>HERMAN LED 1x</p> <p>99</p>



HERMAN LED 2x  99	DAMLA HL141L - HL142L  100	TRONIC HL141 - HL142  100	TRONIC HL143 - HL144  100	MILANO-5 HL835L  101	MILANO-8 HL836L  101
MILANO-13 HL837L  101	PRAG-7 HL823L  102	PRAG-12 HL824L  102	TORINO-23 HL826L  102	TRACK 1M  103	TRACK 2M  103
TRACK POINT  103	CONNECTOR I  103	CONNECTOR L  103	URAL LED  104	TIBET LED  104	AQUA ECO  105
AQUA OPAQUE  105	AQUA WALL FIXTURE  105	AQUA DOLUNAY  106	AQUA DOLUNAY S  107	FRYLIA  108	DAVUS  108
MONAT  109	LOB  109	WIR  109	ZIGANA HL905  110	ALP HL907  110	ARARAT HL906  110
DORUK HL903  110	EVEREST HL908  110	REX  111	ERAST  111	EBEN LED  111	EBEN  111
MANGO-1 HL237  112	MANGO-2 HL238  112	MANGO-3 HL239  112	GRETA E27  113	LIMO E27  113	ASTER GU10  114

# Indeks obrazkowy

cz: Obrázkový index / sk: Obrázkový index

<p>ASTER 2xGU10</p> <p>114</p>	<p>MANOLYA-1 HL265 35W</p> <p>114</p>	<p>MANOLYA-2 HL266 2X35W</p> <p>114</p>	<p>KELER GU10 INOX</p> <p>115</p>	<p>KELER 2xGU10 INOX</p> <p>115</p>	<p>GARDENYA-1 HL246 35W</p> <p>115</p>
<p>GARDENYA-2 HL247 2X35W</p> <p>115</p>	<p>GARDENYA-3 HL248 35W</p> <p>115</p>	<p>GARDENYA-4 HL249 2X35W</p> <p>115</p>	<p>FOREST GU10 C</p> <p>116</p>	<p>FOREST 2xGU10 C</p> <p>116</p>	<p>FOREST GU10 D</p> <p>116</p>
<p>FOREST 2xGU10 D</p> <p>116</p>	<p>TARO LED 2x5W C</p> <p>117</p>	<p>TARO LED 2x5W D</p> <p>117</p>	<p>ARDIC HL237L</p> <p>118</p>	<p>MESE HL238L</p> <p>118</p>	<p>TAFLAN HL240L</p> <p>118</p>
<p>SELVI HL241L</p> <p>118</p>	<p>SALKIM HL242L</p> <p>118</p>	<p>PALMIYE-1 HL295</p> <p>119</p>	<p>PALMIYE-2 HL296</p> <p>119</p>	<p>PALMIYE-3 HL297</p> <p>119</p>	<p>PALMIYE-4 HL298</p> <p>119</p>
<p>WELMA BLACK-60</p> <p>120</p>	<p>WELMA BLACK-80</p> <p>120</p>	<p>WELMA BLACK-100</p> <p>120</p>	<p>BEGONYA2</p> <p>121</p>	<p>BEGONYA1</p> <p>121</p>	<p>PLANT LED 3W</p> <p>122</p>
<p>PLANT LED 5W</p> <p>122</p>	<p>SAFRAN-5 HL281L</p> <p>122</p>	<p>HALLEY LED 0,06W</p> <p>123</p>	<p>MAGIC LED 0,54W</p> <p>123</p>	<p>WIZARD SOLARO LED 2W</p> <p>123</p>	<p>OLIMP LED</p> <p>124</p>
<p>OLIMP LED S</p> <p>124</p>	<p>PUMA LED</p> <p>125</p>	<p>PUMA/S LED</p> <p>125</p>	<p>MARAT CBS-375, 377, 379</p> <p>126</p>	<p>MARAT2 CBS-376, 378</p> <p>126</p>	<p>MARAT3 CBS-381, 383, 385</p> <p>127</p>



MARAT4 CBS-382, 384, 386  127	VEGA 36  128	TRANSFORMER  128	FOCUS HL480  129	LINEA HL482  129	HL485  129
HL486  129	HL470 1000W  129	HELIX HL454  130	ALBA HL455  130	VIOLA HL456  130	SOLO HL457  130
CABLE TIE  131	SPRING CONNECTOR 2 POLE  131	SPRING CONNECTOR 3 POLE  131	TERMINAL BLOCK  131	GU10 CERAMIC  131	T8 LED  132
ERSTE LED E27 3000K  133	ERSTE LED E27 4500K  133	VELA LED E14 3000K  134	ULKE LED E14 3000K  134	ULKE LED E27 3000K  134	FILAMENT LED FLAME E14 2700K  135
FILAMENT LED FLAME E14 4200K  135	FILAMENT LED GLOBE E27 2700K  135	FILAMENT LED GLOBE E27 4200K  135	RAINBOW LED  136	R39  137	R50  137
R63  137	LARA LED GU10  138	BIT SMD LED G9  139	MEGA-3 HL457L  139	MEGA-5 HL458L  139	G9  140
JCDR  141	J 118MM  142	PL 11W  143	MIDI HL459L  144	JC G4  145	JC G6.35  145

# Indeks alfabetyczny

**CZ:** Abecední index / **SK:** Abecedný index

Nazwa produktu CZ: Název výrobku SK: Názov výrobku	Indeks Ideus CZ: Kód Ideus SK: Kód Ideus	Numer strony CZ: Číslo strany SK: Číslo strany	Nazwa produktu CZ: Název výrobku SK: Názov výrobku	Indeks Ideus CZ: Kód Ideus SK: Kód Ideus	Numer strony CZ: Číslo strany SK: Číslo strany
ALBA HL455 60DB	02387	130	BODRUM-1 HL785N MATCHR	00584	77
ALBATROS-4 HL6651L CHROME 4200K	02481	59	BODRUM-2 HL786N MATCHR	00586	77
ALBATROS-6 HL6652L CHROME 4200K	02482	59	BODRUM-3 HL787N MATCHR	00588	77
ALDEN LED C 12W+4W 4000K	02900	43	BODRUM-4 HL788N MATCHR	00590	77
ALDEN LED C 3W+3W 4000K	02898	43	BORYS D SILVER	03139	31
ALDEN LED C 6W+3W 4000K	02899	43	BORYS L SILVER	03140	31
ALDEN LED D 12W+4W 4000K	02903	43	BRENA LED 4W ANTIC BRASS 4000K	03069	58
ALDEN LED D 3W+3W 4000K	02901	43	BRENA LED 4W MAT CHROME 4000K	03068	58
ALDEN LED D 6W+3W 4000K	02902	43	BRENA LED 6W ANTIC BRASS 4000K	03071	58
ALFA-13 HL2001 13W	00849	92	BRENA LED 6W MAT CHROME 4000K	03070	58
ALFA-21 HL2001 21W	00850	92	BUGS HL992L SERCE	02250	87
ALFA-8 HL2001 8W	00848	92	CABLE TIE 2,5*100	00515	131
ALFI LED C 3.5W SILVER 4000K	03099	36	CABLE TIE 2,5*150	00516	131
ALINA LED C 12W+4W 4000K	02894	15	CABLE TIE 3,6*200	00519	131
ALINA LED C 3W+3W 4000K	02892	15	CABLE TIE 3,6*250	00520	131
ALINA LED C 6W+3W 4000K	02893	15	CABLE TIE 4,8*200	00525	131
ALINA LED D 12W+4W 4000K	02897	15	CAFU-2 HL339L LED36	01792	88
ALINA LED D 3W+3W 4000K	02895	15	CINDER LED C 12W 4000K	02880	16
ALINA LED D 6W+3W 4000K	02896	15	CINDER LED C 19W 4000K	02881	16
ALP HL907 BLACK	00484	110	CINDER LED C 24W 4000K	02882	16
ALP HL907 WHITE	00483	110	CINDER LED C 4W 4000K	02878	16
ALUM C SILVER	03096	30	CINDER LED C 9W 4000K	02879	16
ALUM D SILVER	03097	30	CINDER LED D 16W 4000K	02884	16
ALUM L SILVER	03098	30	CINDER LED D 20W 4000K	02885	16
AMELIA LED CHROME 4000K	03056	61	CINDER LED D 8W 4000K	02883	16
ANGELA HL761L MATCHR 4200K	02498	36	CONNECTOR I BLACK	02516	103
AQUA DOLUNAY BLACK	02548	106	CONNECTOR I SILVER	02517	103
AQUA DOLUNAY BLACK S	03076	107	CONNECTOR I WHITE	02515	103
AQUA DOLUNAY WHITE	02941	106	CONNECTOR L BLACK	02519	103
AQUA DOLUNAY WHITE S	02942	107	CONNECTOR L SILVER	02520	103
AQUA ECO BLACK	02260	105	CONNECTOR L WHITE	02518	103
AQUA ECO WHITE	02259	105	DAMLA-20 HL141L 20W 6400K	02626	100
AQUA OPAQUE BLACK	02632	105	DAMLA-40 HL142L 40W 6400K	02627	100
AQUA OPAQUE WHITE	02631	105	DAVUS HPD-309	00309	108
AQUA WALL FIXTURE BLACK	02372	105	DAVUS HPD-311	00311	108
AQUA WALL FIXTURE WHITE	02371	105	DELTA-18 HL160 18W	00841	95
ARARAT HL906 BLACK	00482	110	DELTA-36 HL161 36W	00842	95
ARARAT HL906 WHITE	00481	110	DEO LED 1W	02869	86
ARDIC HL237L BLACK 4100K	02635	118	DONALD HLO43 BLUE	00687	85
ASTER 2xGU10 INOX	03016	114	DONALD HLO43 GREEN	00685	85
ASTER GU10 INOX	03015	114	DONALD HLO43 ORANGE	00686	85
ATMA ACL-343	00343	49	DONAT LED 1C 3000K	02725	68
ATMA ACL-344	00344	49	DONAT LED 2L 3000K	02726	68
AVANOS HL857L CHROME 4200K	02639	64	DONAT LED 3L 3000K	02727	68
BECKHAM-1 HL341L POWER LED1	02697	88	DONAT LED 4L 3000K	02728	68
BEGONYA HL779 ANTIQUE GREEN	01316	35	DORA HL990L WIEZA	02321	87
BEGONYA HL779 ANTIQUE RED COPPER	01317	35	DORI LED BLUE	02788	78
BEGONYA HL779 CHROME	01314	35	DORI LED BLUE CLIP	02867	78
BEGONYA HL779 GOLDEN	01313	35	DORI LED GREEN	02789	78
BEGONYA HL779 MATCHR	01315	35	DORI LED GREEN CLIP	02868	78
BEGONYA HL779 PEARL SILVER/GOLDEN	01318	35	DORI LED ORANGE	02786	78
BEGONYA HL779 TITANIUM BLACK/GOLDEN	01319	35	DORI LED ORANGE CLIP	02865	78
BEGONYA1 BLACK	03079	121	DORI LED RED	02787	78
BEGONYA1 WHITE	03078	121	DORI LED RED CLIP	02866	78
BEGONYA2 BLACK	03081	121	DORUK HL903 BLACK	00475	110
BEGONYA2 WHITE	03080	121	DORUK HL903 GREY	00476	110
BETI LED C 10W 4000K	03101	63	DORUK HL903 WHITE	00474	110
BETI LED C 5W 4000K	03100	63	DUFFY HL994L MOTYL	02251	87
BETI LED L 10W 4000K	03103	63	EBEN 60 GREY PRO	02392	111
BETI LED L 5W 4000K	03102	63	EBEN 60 WHITE	02391	111
BIG SQUARE CLASSIC MAPLE	02001	57	EBEN LED WHITE	02749	111
BIG SQUARE CLASSIC SILVER	01998	57	EGO LED 0,5W	02790	86
BIG SQUARE CLASSIC WALNUT	02000	57	ELENA-1 HL670L MATCHR 2700K	01691	19
BIG SQUARE CLASSIC WHITE	01997	57	ELENA-1 HL670L MATCHR 6400K	01692	19
BIG SQUARE MODERN MAPLE	02006	57	ELENA-3 HL672L CHR+MATCHR 2700K	01695	20
BIG SQUARE MODERN WALNUT	02005	57	ELENA-3 HL672L CHR+MATCHR 6400K	01696	20
BIG SQUARE MODERN WHITE	02002	57	ELENA-6 HL674L CHR+MATCHR 2700K	01699	21
BIG UFO BULUT GOLDEN	02009	56	ELENA-6 HL674L CHR+MATCHR 6400K	01700	21
BIG UFO BULUT SILVER	02008	56	EPOS G9 1D	02777	73
BIG UFO BULUT WALNUT	02010	56	EPOS G9 2L	02778	73
BIG UFO BULUT WHITE	02007	56	EPOS G9 3L	02779	73
BIG UFO ZAGREP GOLDEN	02014	56	EPOS G9 4L	02835	73
BIG UFO ZAGREP MAPLE	02016	56	ERAST HPD-320	00320	111
BIG UFO ZAGREP WHITE	02012	56	ERDEK HL855L WHITE 4000K	02638	64
BIT SMD LED G9 2.5W 3000K	02765	139	ERSTE LED E27 10W 3000K	02754	133
BIT SMD LED G9 2.5W 4500K	02549	139	ERSTE LED E27 10W 4500K	02794	133
BIT SMD LED G9 2.5W 6500K	02766	139	ERSTE LED E27 12W 3000K	02755	133



Nazwa produktu cz: Název výrobku sk: Názov výrobku	Indeks Ideus cz: Kód Ideus sk: Kód Ideus	Numer strony cz: Číslo strany sk: Číslo strany	Nazwa produktu cz: Název výrobku sk: Názov výrobku	Indeks Ideus cz: Kód Ideus sk: Kód Ideus	Numer strony cz: Číslo strany sk: Číslo strany
ERSTE LED E27 12W 4500K	02795	133	J 118MM 200W	01362	142
ERSTE LED E27 14W 3000K	03059	133	J 118MM 300W	01363	142
ERSTE LED E27 14W 4500K	03060	133	J 118MM 500W	01364	142
ERSTE LED E27 7W 3000K	02753	133	JC G4 10W	01352	145
EVEREST HL908 BLACK	00486	110	JC G4 20W	01353	145
EVEREST HL908 WHITE	00485	110	JC G4 35W	01354	145
FILAMENT LED FLAME-2 2700K	02994	135	JC G6.35 50W	01355	145
FILAMENT LED FLAME-2 4200K	02995	135	JCDR CLOSED 35W	01387	141
FILAMENT LED FLAME-4 2700K	02996	135	JCDR CLOSED 50W	01388	141
FILAMENT LED FLAME-4 4200K	02997	135	JULIA LED 3W 4200K	02933	18
FILAMENT LED GLOBE-4 2700K	02998	135	KAMI LED C 3,5W WHITE 4000K	03121	37
FILAMENT LED GLOBE-4 4200K	02999	135	KAMI LED C 3,5W WHITE 5700K	03122	37
FILAMENT LED GLOBE-6 2700K	03000	135	KAMI LED D 3,5W WHITE 4000K	03123	37
FILAMENT LED GLOBE-6 4200K	03001	135	KAMI LED D 3,5W WHITE 5700K	03124	37
FILAMENT LED GLOBE-8 2700K	03002	135	KATI E27 BLUE	02859	82
FILAMENT LED GLOBE-8 4200K	03003	135	KATI E27 BLUE CLIP	02863	82
FLAMINGO-4 HL6641L CHROME 4200K	02479	58	KATI E27 GREEN	02860	82
FLAMINGO-6 HL6642L CHROME 4200K	02480	58	KATI E27 GREEN CLIP	02864	82
FLAT LED 10W 4000K	02913	96	KATI E27 RED	02858	82
FLAT LED 20W 4000K	02914	96	KATI E27 RED CLIP	02862	82
FLAT LED 30W 4000K	02915	96	KATI E27 WHITE	02857	82
FLAT LED 40W 4000K	02916	96	KATI E27 WHITE CLIP	02861	82
FLATER LED 10W 4000K	03093	97	KELER 2xGU10 INOX	03018	115
FLATER LED 20W 4000K	03094	97	KELER GU10 INOX	03017	115
FLORYA-3 LED CHROME	02936	65	KEMER-1 HL715 CHROME	00554	74
FLORYA-6 LED CHROME	02937	65	KEMER-2 HL716 CHROME	00555	74
FLUE WALL FIXTURE MAPLE	02027	54	KEMER-3 HL717 CHROME	00556	74
FLUE WALL FIXTURE WALNUT	02026	54	KEMER-4 HL718 CHROME	00557	74
FLUE WALL FIXTURE WHITE	02023	54	KEMER-5 HL719 CHROME	00558	74
FOCUS HL480 WHITE	01841	129	KENT LED 1D 3000K	02769	66
FOREST 2xGU10 C	03012	116	KENT LED 2L 3000K	02770	66
FOREST 2xGU10 D	03014	116	KENT LED 3L 3000K	02771	66
FOREST GU10 C	03011	116	KENT LED 4D 3000K	02772	66
FOREST GU10 D	03013	116	KITTY HLO36 BLUE	00665	83
FRYLIA HPD-323	00323	108	KITTY HLO36 GREEN	00664	83
FRYLIA HPD-324	00324	108	KITTY HLO36 PINK	00666	83
G9 25W CLEAR	01346	140	KOMBI GU10 1C	02836	75
G9 40W CLEAR	01349	140	KOMBI GU10 2L	02837	75
GABI LED 1D 3000K	02846	62	KOMBI GU10 3L	02838	75
GABI LED 2L 3000K	02847	62	KOMBI GU10 4D	02839	75
GALAKSI HL562L 32W WHITE 2700K	02814	98	KONAK-1 HL635S CHROME+MATCHR	00621	50
GALAKSI HL562L 32W WHITE 6400K	02815	98	KONAK-2 HL635M CHROME+MATCHR	00622	50
GARDENYA-1 HL246 35W	01158	115	KONAK-3 HL635B CHROME+MATCHR	00624	50
GARDENYA-2 HL247 2X35W	01159	115	KRYSTAL LED WHITE	02935	39
GARDENYA-3 HL248 35W	01161	115	KRISTIN G9 1D	02986	72
GARDENYA-4 HL249 2X35W	01162	115	KRISTIN G9 2L	02987	72
GLOP FAVORI	01986	52	KRISTIN G9 3L	02988	72
GLOP WIND ROSE	01985	52	KRISTIN G9 4D	02989	72
GOLD LED 6400K	03004	39	KUGU LORI LED 1V 3W	02791	65
GOTI LED C 5W 4000K	03083	17	LARA LED GU10 4W 3000K	02757	138
GOTI LED D 5W 4000K	03084	17	LARA LED GU10 6W 3000K	02758	138
GRETA E27 DARK GREY	03019	113	LATE LED 3m 180 CW	03023	93
GU10 CERAMIC	02542	131	LATE LED 3m 180 CW BLISTER	03033	94
GUSTI LED 10W 4000K	03106	41	LATE LED 3m 180 CW IP65	03025	93
GUSTI LED 3W 4000K	03104	41	LATE LED 3m 180 CW IP65 BLISTER	03035	94
GUSTI LED 7W 4000K	03105	41	LATE LED 3m 180 WW	03022	93
HALLEY LED 0,06W 6500K	02965	123	LATE LED 3m 180 WW BLISTER	03032	94
HANNA C CHROME	02922	28	LATE LED 3m 180 WW IP65	03024	93
HELIX HL454 60DB	00739	130	LATE LED 3m 180 WW IP65 BLISTER	03034	94
HERMAN LED 18W	02926	99	LATE LED 3m 90 RGB BLISTER	03030	94
HERMAN LED 2x18W	02928	99	LATE LED 3m 90 RGB BLISTER IP65	03031	94
HERMAN LED 2x36W	02929	99	LATE LED 5m 150 RGB BLISTER	03036	94
HERMAN LED 36W	02927	99	LATE LED 5m 150 RGB BLISTER IP65	03037	94
HL182L 2700K	02692	98	LATE LED 5m 300 CW	03027	93
HL470 1000W	01563	129	LATE LED 5m 300 CW BLISTER	03039	94
HL485 WHITE	02496	129	LATE LED 5m 300 CW IP65	03029	93
HL486 WHITE	02698	129	LATE LED 5m 300 CW IP65 BLISTER	03041	94
IGOR LED C 6W WHITE 4000K	03125	42	LATE LED 5m 300 WW	03026	93
IGOR LED C 9W WHITE 4000K	03126	42	LATE LED 5m 300 WW BLISTER	03038	94
IGOR LED D 6W WHITE 4000K	03127	42	LATE LED 5m 300 WW IP65	03028	93
IGOR LED D 9W WHITE 4000K	03128	42	LATE LED 5m 300 WW IP65 BLISTER	03040	94
ILGAZ-1 HL634S CHROME+MATCHR	00617	50	LEON LED 12W 4000K	02780	46
ILGAZ-2 HL634M CHROME+MATCHR	00618	50	LEON LED 16W 4000K	02781	46
ILGAZ-3 HL634B CHROME+MATCHR	00620	50	LEON LED 24W 4000K	02782	46
IREM LED BLACK	02940	80	LEON LED S 12W 4000K	03063	47
IREM LED RED	02939	80	LEON LED S 16W 4000K	03064	47
IREM LED WHITE	02938	80	LIKYA LED-1 3000K	03134	67

# Indeks alfabetyczny

cz: Abecední index / sk: Abecedný index

Nazwa produktu cz: Název výrobku sk: Názov výrobku	Indeks Ideus cz: Kód Ideus sk: Kód Ideus	Numer strony cz: Číslo strany sk: Číslo strany	Nazwa produktu cz: Název výrobku sk: Názov výrobku	Indeks Ideus cz: Kód Ideus sk: Kód Ideus	Numer strony cz: Číslo strany sk: Číslo strany
LIKYA LED-2 3000K	03135	67	MOLLY HL037 GREEN	00667	84
LIKYA LED-3 3000K	03136	67	MOLLY HL037 PINK	00669	84
LIKYA LED-4 3000K	03137	67	MONAT 100 WHITE	02393	109
LIKYA LED-5 3000K	03138	67	MYS LED 0.5W	02870	86
LILYA-3 HL698LE 2700K	02551	22	NADIA G9 CHROME	01674	60
LILYA-3 HL698LE 6400K	02550	22	NADIA G9 MAT CHROME	01675	60
LILYA-5 HL699LE 2700K	02553	22	NELI LED 1L 3000K	02828	69
LILYA-5 HL699LE 6400K	02552	22	NELI LED 2I 3000K	02829	69
LIMO E27 DARK GREY	03133	113	NELI LED 3C 3000K	02832	69
LINEA HL482 WHITE	01845	129	NELI LED 3I 3000K	02830	69
LISA LED 3W 4200K	02934	18	NELI LED 4I 3000K	02831	69
LOB 100 WHITE	02676	109	NERGIS HL801 BROWN	01343	29
LOLLY WHITE	02369	53	NERGIS HL801 CLEAR	01341	29
MAGIC LED 0,54W 6500K	02963	123	NINOVA WALL FIXTURE MAPLE	02032	54
MANAVGAT-1 HL790N CHROME	00592	76	NINOVA WALL FIXTURE WALNUT	02031	54
MANAVGAT-2 HL791N CHROME	00594	76	NINOVA WALL FIXTURE WHITE	02028	54
MANAVGAT-3 HL792N CHROME	00596	76	NUFER HL800 BROWN	01338	29
MANAVGAT-4 HL793N CHROME	00598	76	NUFER HL800 CLEAR	01336	29
MANAVGAT-5 HL794N CHROME	00599	76	OLIMP LED 100W BLACK 4500K	02930	124
MANGO-1 HL237 15W	01146	112	OLIMP LED 10W BLACK 4500K	02820	124
MANGO-2 HL238 15W	01147	112	OLIMP LED 20W BLACK 4500K	02821	124
MANGO-3 HL239 15W	01148	112	OLIMP LED 30W BLACK 4500K	02822	124
MANOLYA-1 HL265 35W	01177	114	OLIMP LED 50W BLACK 4500K	02823	124
MANOLYA-2 HL266 2X35W	01178	114	OLIMP LED S 10W BLACK 4500K	02824	124
MARAT CBS-375	00375	126	OLIMP LED S 20W BLACK 4500K	02825	124
MARAT CBS-377	00377	126	OLIMP LED S 30W BLACK 4500K	02826	124
MARAT CBS-379	00379	126	OLIMP LED S 50W BLACK 4500K	02827	124
MARAT2 CBS-376	00376	126	ORKIDE HL750 CHROME	01209	32
MARAT2 CBS-378	00378	126	ORKIDE HL750 GOLDEN	01208	32
MARAT3 CBS-381	00381	127	ORKIDE HL750 MATCHR	01210	32
MARAT3 CBS-383	00383	127	ORKIDE HL750 WHITE	01207	32
MARAT3 CBS-385	00385	127	ORTANCA HL755 CHROME	01231	34
MARAT4 CBS-382	00382	127	ORTANCA HL755 MATCHR	01232	34
MARAT4 CBS-384	00384	127	PALMIYE-1 HL295 100W	01203	119
MARAT4 CBS-386	00386	127	PALMIYE-2 HL296 100W	01204	119
MARTIN LED C 12W 4000K	02905	45	PALMIYE-3 HL297 100W	01205	119
MARTIN LED C 18W 4000K	02906	45	PALMIYE-4 HL298 100W	01206	119
MARTIN LED C 24W 4000K	02907	45	PARIS G9 1D	03054	71
MARTIN LED C 6W 4000K	02904	45	PARIS G9 2L	03055	71
MARTIN LED D 12W 4000K	02909	45	PELE-1 HL3094L LED4	02384	88
MARTIN LED D 18W 4000K	02910	45	PELE-2 HL3097L LED7	02385	88
MARTIN LED D 24W 4000K	02911	45	PELIKAN HL6631L CHROME 4200K	02701	58
MARTIN LED D 6W 4000K	02908	45	PL 11W 6400K	00916	143
MAX HL993L ROZA	02252	87	PLANT LED 3W BLACK 4500K	03129	122
MEGA-3 HL457L 3W 2700K	02712	139	PLANT LED 5W BLACK 4500K	03130	122
MEGA-3 HL457L 3W 6400K	02713	139	PRAG-12 HL824L BLACK 4200K	02431	102
MEGA-5 HL458L 5W 2700K	02714	139	PRAG-12 HL824L SILVER 4200K	02432	102
MEGA-5 HL458L 5W 6400K	02715	139	PRAG-12 HL824L WHITE 4200K	02430	102
MENEKSE HL752 CHROME	01218	33	PRAG-7 HL823L BLACK 4200K	02428	102
MENEKSE HL752 GOLDEN	01217	33	PRAG-7 HL823L SILVER 4200K	02429	102
MENEKSE HL752 GREY	01216	33	PRAG-7 HL823L WHITE 4200K	02427	102
MENEKSE HL752 MATCHR	01219	33	PUMA 10 LED 6400K	02946	125
MENEKSE HL752 RED COPPER	01220	33	PUMA 100 LED 6400K	02954	125
MENEKSE HL752 WHITE	01215	33	PUMA 20 LED 6400K	02948	125
MESE HL238L BLACK 4100K	02636	118	PUMA 30 LED 6400K	02950	125
MIDI HL459L 1,5W 2700K	02716	144	PUMA 50 LED 6400K	02952	125
MIDI HL459L 1,5W 6400K	02717	144	PUMA/S-10 LED 6400K	02957	125
MILANO-13 HL837L BLACK 4200K	02723	101	PUMA/S-20 LED 6400K	02958	125
MILANO-13 HL837L SILVER 4200K	02724	101	PUMA/S-30 LED 6400K	02959	125
MILANO-13 HL837L WHITE 4200K	02736	101	PUMA/S-50 LED 6400K	02961	125
MILANO-5 HL835L BLACK 4200K	02718	101	PUNTO-36 HL162 2X18W	00843	95
MILANO-5 HL835L SILVER 4200K	02719	101	PUNTO-72 HL163 2X36W	00844	95
MILANO-5 HL835L WHITE 4200K	02735	101	PUSKAS-1 HL331L LED4	01784	88
MILANO-8 HL836L BLACK 4200K	02721	101	PUSKAS-2 HL332L LED5	01785	88
MILANO-8 HL836L SILVER 4200K	02722	101	PUSKAS-3 HL333L LED9	01786	88
MILANO-8 HL836L WHITE 4200K	02720	101	R39 30W FROSTED	01794	137
MILTON LED C 12W MATCHR 3000K	02132	25	R50 40W FROSTED	01802	137
MILTON LED C 6W MATCHR 3000K	02124	24	R50 60W FROSTED	01803	137
MILTON LED D 12W MATCHR 3000K	02128	25	R63 60W FROSTED	01809	137
MILTON LED D 12W MATCHR 5700K	02127	25	RAFI LED C 3W MAT CHROME 4000K	03118	38
MILTON LED D 12W WHITE 3000K	02126	25	RAFI LED C 3W WHITE 4000K	03117	38
MILTON LED D 12W WHITE 5700K	02125	25	RAFI LED D 3W MAT CHROME 4000K	03120	38
MILTON LED D 6W MATCHR 3000K	02120	24	RAFI LED D 3W WHITE 4000K	03119	38
MILTON LED D 6W MATCHR 5700K	02119	24	RAINBOW LED 1W BLUE	02975	136
MILTON LED D 6W WHITE 3000K	02118	24	RAINBOW LED 1W GREEN	02978	136
MILTON LED D 6W WHITE 5700K	02117	24	RAINBOW LED 1W RED	02977	136
MOLLY HL037 BLUE	00668	84	RAINBOW LED 1W YELLOW	02976	136



Nazwa produktu cz: Název výrobku sk: Názov výrobku	Indeks Ideus cz: Kód Ideus sk: Kód Ideus	Numer strony cz: Číslo strany sk: Číslo strany	Nazwa produktu cz: Název výrobku sk: Názov výrobku	Indeks Ideus cz: Kód Ideus sk: Kód Ideus	Numer strony cz: Číslo strany sk: Číslo strany
REX 60 WHITE	02748	111	T8 LED 18W 4000K 1,2	02932	132
REX HL991L SLONCE	02261	87	T8 LED 9W 4000K 0,6	02931	132
RIANA C CHROME	02921	28	TAFLAN HL240L BLACK 4100K	02694	118
RIANA C MULTI	02920	28	TARO LED 2x5W C	03020	117
RIANA LED C CHROME 6500K	02918	27	TARO LED 2x5W D	03021	117
RIANA LED C CHROME RGB	02917	27	TERMINAL BLOCK 3A 4MM2	01968	131
RITON LED 4W ANTIC BRASS 4000K	03073	59	TERMINAL BLOCK 5A 6MM2	01969	131
RITON LED 4W MAT CHROME 4000K	03072	59	TIBET LED WHITE	02944	104
RITON LED 6W ANTIC BRASS 4000K	03075	59	TINA SENSORLU LED 360 WHITE	02807	48
RITON LED 6W MAT CHROME 4000K	03074	59	TOLA E27 BLUE	02851	81
ROBIN LED C 12W 4000K	03086	44	TOLA E27 BLUE CLIP	02855	81
ROBIN LED C 18W 4000K	03087	44	TOLA E27 RED	02850	81
ROBIN LED C 24W 4000K	03088	44	TOLA E27 RED CLIP	02854	81
ROBIN LED C 6W 4000K	03085	44	TOLA E27 SILVER	02852	81
ROBIN LED D 12W 4000K	03090	44	TOLA E27 SILVER CLIP	02856	81
ROBIN LED D 18W 4000K	03091	44	TOLA E27 WHITE	02849	81
ROBIN LED D 24W 4000K	03092	44	TOLA E27 WHITE CLIP	02853	81
ROBIN LED D 6W 4000K	03089	44	TORINO-23 HL826L BLACK 4200K	02687	102
ROLEN LED 10W 4000K	03109	40	TORINO-23 HL826L SILVER 4200K	02688	102
ROLEN LED 15W 4000K	03110	40	TORINO-23 HL826L WHITE 4200K	02686	102
ROLEN LED 3W 4000K	03107	40	TRACK 1M BLACK	02437	103
ROLEN LED 7W 4000K	03108	40	TRACK 1M SILVER	02438	103
RONI LED BLACK CLIP	02877	79	TRACK 1M WHITE	02436	103
RONI LED BLUE	02873	79	TRACK 2M BLACK	02440	103
RONI LED GREEN	02875	79	TRACK 2M SILVER	02441	103
RONI LED PINK	02874	79	TRACK 2M WHITE	02439	103
RONI LED SILVER CLIP	02876	79	TRACK POINT BLACK	02704	103
RONI LED WHITE CLIP	02923	79	TRACK POINT SILVER	02703	103
RUDA LED 1C 3000K	02840	70	TRACK POINT WHITE	02702	103
RUDA LED 2L 3000K	02841	70	TRANSFORMER-105 HL371 105W	00834	128
RUDA LED 3I 3000K	02842	70	TRANSFORMER-150 HL372 150W	00835	128
RUDA LED 4I 3000K	02843	70	TRANSFORMER-60 HL370 60W	00833	128
SAFRAN-5 HL281L BLACK	02741	122	TRONIC-1020 HL141 18W	01976	100
SAFRAN-5 HL281L WHITE	02742	122	TRONIC-1040 HL142 36W	01978	100
SALKIM HL242L BLACK 4100K	02696	118	TRONIC-2020 HL143 2X18W	01979	100
SELVI HL241L BLACK 4100K	02695	118	TRONIC-2040 HL144 2X36W	01980	100
SENSORLU 360 KARO	02545	48	TURKUAZ HL564L 32W WHITE 2700K	02816	98
SIGMA-10 HL2001L 10W	02691	91	TURKUAZ HL564L 32W WHITE 6400K	02817	98
SIGMA-4 HL2001L 4W	02689	91	TURNA LORI LED 1U 3W	02792	65
SIGMA-7 HL2001L 7W	02690	91	UFO ERCCYIES	01984	51
SIMPSON HL981L WHITE	02554	86	UFO NAZAR	01982	51
SLIM-12 HL563L 12W WHITE 2700K	02485	26	UFO STAR	02223	51
SLIM-12 HL563L 12W WHITE 6400K	02486	26	UFO WIND ROSE	01981	51
SLIM-15 HL563L 15W WHITE 2700K	02812	26	UFO ZAGREP	01983	51
SLIM-15 HL563L 15W WHITE 6400K	02813	26	ULKE LED E14 4W 3000K	02803	134
SLIM-18 HL563L 18W WHITE 2700K	02487	26	ULKE LED E14 6W 3000K	02805	134
SLIM-18 HL563L 18W WHITE 6400K	02488	26	ULKE LED E27 4W 3000K	03061	134
SLIM-24 HL563L 24W WHITE 2700K	02489	26	ULKE LED E27 6W 3000K	03062	134
SLIM-24 HL563L 24W WHITE 6400K	02490	26	URAL LED WHITE	02943	104
SLIM-3 HL563L 3W WHITE 2700K	02808	26	VEGA 36	03082	128
SLIM-3 HL563L 3W WHITE 6400K	02809	26	VELA LED E14 4W 3000K	02799	134
SLIM-6 HL563L 6W WHITE 2700K	02810	26	VELA LED E14 6W 3000K	02801	134
SLIM-6 HL563L 6W WHITE 6400K	02811	26	VERA-1 HL671L MATCHR 2700K	01693	19
SLIM-9 HL563L 9W WHITE 2700K	02483	26	VERA-1 HL671L MATCHR 6400K	01694	19
SLIM-9 HL563L 9W WHITE 6400K	02484	26	VERA-12 HL676L CHR+MATCHR 2700K	01703	21
SOLA LED 12W 4000K	02783	46	VERA-12 HL676L CHR+MATCHR 6400K	01704	21
SOLA LED 16W 4000K	02784	46	VERA-3 HL673L CHR+MATCHR 2700K	01697	20
SOLA LED 24W 4000K	02785	46	VERA-3 HL673L CHR+MATCHR 6400K	01698	20
SOLA LED S 12W 4000K	03065	47	VERA-6 HL675L CHR+MATCHR 2700K	01701	21
SOLA LED S 16W 4000K	03066	47	VERA-6 HL675L CHR+MATCHR 6400K	01702	21
SOLO HL457 60DB	02389	130	VICTORIA-3 HL678L 2700K	02264	23
SPRING CONNECTOR 2 POLE 1.5MM	02546	131	VICTORIA-3 HL678L 6500K	02265	23
SPRING CONNECTOR 2 POLE 2.5MM	03057	131	VIOLA HL456 60DB	02388	130
SPRING CONNECTOR 3 POLE 1.5MM	02547	131	WARTE 60 BLACK	02677	89
SPRING CONNECTOR 3 POLE 2.5MM	03058	131	WELMA BLACK-100	00395	120
SQUARE CLASSIC MAPLE	01991	55	WELMA BLACK-60	00393	120
SQUARE CLASSIC SILVER	01988	55	WELMA BLACK-80	00394	120
SQUARE CLASSIC WALNUT	01990	55	WIR 75 WHITE	02746	109
SQUARE CLASSIC WHITE	01987	55	WIZARD SOLARO LED 2W 6500K	02848	123
SQUARE MODERN MAPLE	01996	55	ZICO-4 HL313L LED32	01770	90
SQUARE MODERN SILVER	01993	55	ZICO-6 HL312L LED60	01769	90
SQUARE MODERN WALNUT	01995	55	ZIGANA HL905 BLACK	00480	110
SQUARE MODERN WHITE	01992	55	ZIGANA HL905 WHITE	00479	110
STAN D CHROME	02924	28	ZUZA LED 1L 3000K	02844	62
STAN D MULTI	02925	28	ZUZA LED 2L 3000K	02845	62
STAN L CHROME	03095	28			
STAN LED D CHROME 6500K	02919	27			

15-35	<b>oprawy wpuszczane</b> cz: vestavná svítidla / sk: vstavané svietidlá
36-36	<b>oprawy meblowe</b> cz: nábytková svítidla / sk: nábytkové svietidlá
37-39	<b>oprawy przyschodowe</b> cz: schodišťová svítidla / sk: schodiskové svietidlá
40-57	<b>plafonierey wewnętrzne</b> cz: vnitřní stropní svítidla / sk: vnútorné stropné svietidlá
58-60	<b>oprawy nad obrazy i lustra</b> cz: svítidla nad obrazy a zrcadla / sk: svietidlá nad obrazy a zrkadlá
61-62	<b>oprawy do łazienek</b> cz: koupelnová svítidla / sk: kúpeľňová svietidlá
63-65	<b>oprawy dekoracyjne</b> cz: dekorativní svítidla / sk: dekoratívne svietidlá
66-77	<b>oprawy ściennie-sufitowe</b> cz: nástěnná a stropní svítidla / sk: nástenné a stropné svietidlá
78-85	<b>lampki biurkowe i dziecięce</b> cz: stolní lampy pro děti / sk: stolové lampy pre deti
86-87	<b>lampki wtykowe</b> cz: lampy s patičí / sk: lampy s pätičou
88-90	<b>latarki i oprawy akumulatorowe</b> cz: akumulátorové baterky a svítidla / sk: akumulátorové baterky a svietidlá
91-92	<b>oprawy podszafkowe</b> cz: skříňová svítidla / sk: skriňová svietidlá
93-94	<b>paski LED</b> cz: LED pásky / sk: LED pásy
95-100	<b>oprawy techniczne</b> cz: technická svítidla / sk: technická svietidlá
101-103	<b>oświetleniowe systemy szynowe</b> cz: lištvové systémy / sk: lištové systémy
104-118	<b>zewnętrzne plafonierey i kinkiety</b> cz: venkovní stropní a nástěnná svítidla / sk: vonkajšie stropné a nástenné svietidlá
119-125	<b>oprawy ogrodowe i naświetlacze</b> cz: zahradní svítidla a reflektory / sk: záhradné svietidlá a reflektory
126-127	<b>rozdzielnice elektryczne</b> cz: rozváděč / sk: rozvádzač
128-131	<b>urządzenia elektryczne i osprzęt</b> cz: elektrická zařízení a příslušenství / sk: elektrické zariadenia a príslušenstvo
132-145	<b>źródła światła</b> cz: zdroje světla / sk: zdroje svetla





1 ALINA LED C 3W+3W 4000K



2 ALINA LED C 6W+3W 4000K



3 ALINA LED C 12W+4W 4000K



5 ALINA LED D 6W+3W 4000K



6 ALINA LED D 12W+4W 4000K



4 ALINA LED D 3W+3W 4000K

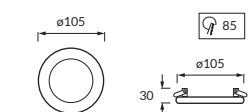

1 ALINA LED C 3W+3W 4000K

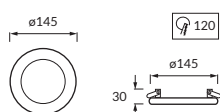

2 ALINA LED C 6W+3W 4000K

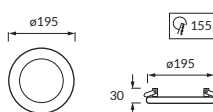

3 ALINA LED C 12W+4W 4000K

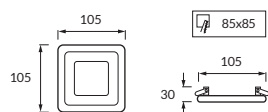

4 ALINA LED D 3W+3W 4000K

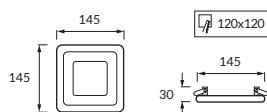

5 ALINA LED D 6W+3W 4000K

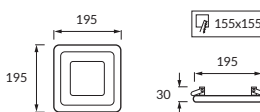

6 ALINA LED D 12W+4W 4000K

220-240V-	SMD LED	$140^\circ$	CRI >80	30000h
4000K	$140^\circ$	CRI >80	30000h	
IP 42		0,5		

**Materiał / Materiál / Material**

PL: odlew stopu aluminium, szkło akrylowe

CZ: odlitek z hliníkové slitiny, akrylové sklo

SK: odliatok z hliníkovej zliatiny, akrylátové sklo

**Uwagi / Komentář / Kommentäre**

PL: zašilacz w komplecie

CZ: napájecí zdroj je součástí dodávky

SK: napájací zdroj je súčasťou dodávky

**Uwagi / Komentář / Kommentäre**

PL: ramka świeci na niebiesko

CZ: rámeček svítí modře

SK: rámček svieti modro

**Uwagi / Komentář / Kommentäre**

możliwość włączenia światła białego  
 PL: lub niebieskiego lub jednocześnie białego i niebieskiego

CZ: možnost zapnout bílé světlo, modré světlo nebo obojí, modré i bílé

SK: možnosť zapnúť biele svetlo, modré svetlo alebo oboje, modré aj biele

Image	Code	Model	Power	Light Flux	Color	Barcode
	01234	ABCDE				
1	02892	ALINA LED C 3W+3W 4000K	3 W + 3 W	270 lm	biały biłá biely	5901477328923
2	02893	ALINA LED C 6W+3W 4000K	6 W + 3 W	540 lm		5901477328930
3	02894	ALINA LED C 12W+4W 4000K	12 W + 4 W	1080 lm		5901477328947
4	02895	ALINA LED D 3W+3W 4000K	3 W + 3 W	270 lm		5901477328954
5	02896	ALINA LED D 6W+3W 4000K	6 W + 3 W	540 lm		5901477328961
6	02897	ALINA LED D 12W+4W 4000K	12 W + 4 W	1080 lm		5901477328978

PL: W skład oprawy wchodzi wbudowane lampy LED  
 CZ: Toto svítidlo obsahuje zabudované světelné zdroje LED  
 SK: Toto svetidlo obsahuje zabudované svetelné zdroje LED

**LED**

PL: Nie można wymieniać lamp w oprawie  
 CZ: Světelné zdroje v tomto svítidle nelze vyměnit  
 SK: Svetelné zdroje v svetidle sa nedajú vymeniť

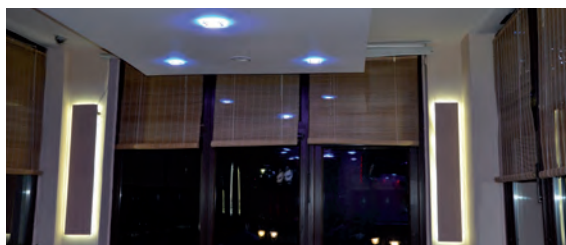

# CINDER LED

Oprawa typu downlight SMD LED

cz: Svítidlo typu „downlight” SMD LED / sk: Svetidlo typu „downlight” SMD LED



1 CINDER LED C 4W 4000K



2 CINDER LED C 9W 4000K



3 CINDER LED C 12W 4000K



4 CINDER LED C 19W 4000K



5 CINDER LED C 24W 4000K



6 CINDER LED D 8W 4000K



7 CINDER LED D 16W 4000K



8 CINDER LED D 20W 4000K

220-240V-	SMD LED		
Tc (K) 5000K	140°	CRI >80	30000h
IP 20		0,5	

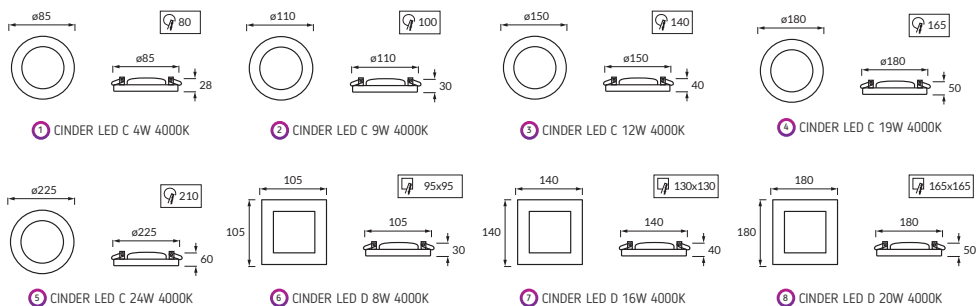

**Materiał / Materiál / Material**  
 PL: odlzew stopu aluminium  
 CZ: odlitek z hliníkové slitiny  
 SK: odliatok z hliníkovej zliatiny

**Uwagi / Komentář / Kommentäre**  
 PL: zasilacz w komplecie  
 CZ: napájecí zdroj je součástí dodávky  
 SK: napájací zdroj je súčasťou dodávky

	01234	ABCDE					
1	02878	CINDER LED C 4W 4000K	4 W	340 lm	biały biłá biely	neutralna biela neutrálňí biłá neutrálna biela	5901477328787
2	02879	CINDER LED C 9W 4000K	9 W	765 lm			5901477328794
3	02880	CINDER LED C 12W 4000K	12 W	960 lm			5901477328800
4	02881	CINDER LED C 19W 4000K	19 W	1615 lm			5901477328817
5	02882	CINDER LED C 24W 4000K	24 W	2040 lm			5901477328824
6	02883	CINDER LED D 8W 4000K	8 W	680 lm			5901477328831
7	02884	CINDER LED D 16W 4000K	16 W	1360 lm			5901477328848
8	02885	CINDER LED D 20W 4000K	20 W	1700 lm			5901477328855

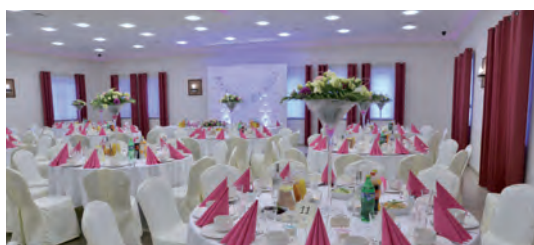

PL: W skład oprawy wchodzi wbudowane lampy LED  
 CZ: Toto svítidlo obsahuje zabudované světelné zdroje LED  
 SK: Toto svietidlo obsahuje zabudované svetelné zdroje LED

PL: Nie można wymieniać lamp w oprawie  
 CZ: Světelné zdroje v tomto svítidle nelze vyměnit  
 SK: Svetelné zdroje v svietidle sa nedajú vymeniť



1 GOTI LED C 5W 4000K

2 GOTI LED D 5W 4000K

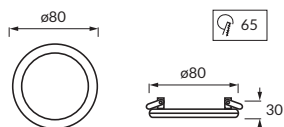

1 GOTI LED C 5W 4000K

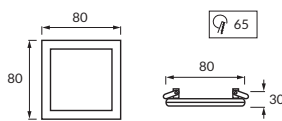

2 GOTI LED D 5W 4000K

220-240V~	5W	SMD LED	350lm
		Tc: K1 SMD3035	160°
CRI >80	30000h	IP 20	
0,5			

	01234	ABCDE			
1	03083	GOTI LED C 5W 4000K	biały biela biely	neutralna biela neutrální biela neutrálna biela	5901477330834
2	03084	GOTI LED D 5W 4000K			5901477330841

**Materiał / Materiál / Materiál**

PL: odlew stopu aluminium, szkło akrylowe  
 cz: odlitek z hliníkové slitiny, akrylové sklo  
 sk: odliatok z hliníkovej zliatiny, akrylátové sklo

**Uwagi / Komentář / Komentäre**

PL: zasilacz w komplecie  
 cz: napájecí zdroj je součástí dodávky  
 sk: napájací zdroj je súčasťou dodávky



PL: W skład oprawy wchodzi wbudowane lampy LED  
 cz: Toto svítidlo obsahuje zabudované světelné zdroje LED  
 sk: Toto svetidlo obsahuje zabudované svetelné zdroje LED

PL: Nie można wymieniać lamp w oprawie  
 cz: Světelné zdroje v tomto svítidle nelze vyměnit  
 sk: Svetelné zdroje v svetidle sa nedajú vymeniť



# JULIA LED / LISA LED

## Oprawa dekoracyjna COB LED

**CZ:** Dekorační COB LED svítidlo / **SK:** Dekoračné COB LED svetidlo



1 JULIA LED 3W 4200K

2 LISA LED 3W 4200K

220-240V~	3W	COB LED	125lm
		$T_c(K)$ SDCM $\leq 6$ 4000K	120°
CRI >80	30000h	IP 20	
0,5			

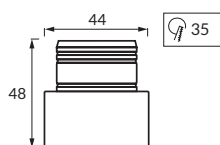

1 JULIA LED 3W 4200K

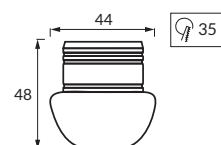

2 LISA LED 3W 4200K

<b>Materiał / Materiál / Material</b>
PL: blacha stalowa, szkło
CZ: kovový výlisek, sklo
SK: kovový výlisok, sklo

<b>Uwagi / Komentář / Komentáre</b>
PL: zasilacz w komplecie
CZ: napájecí zdroj je součástí dodávky
SK: napájací zdroj je súčasťou dodávky

	01234	ABCDE			
1	02933	JULIA LED 3W 4200K	przezroczysty+czerwony průhledný+černá	neutralna biała neutrálnej biela	5901477329333
2	02934	LISA LED 3W 4200K	priehľadný+čierna	neutralna biała	5901477329340



PL: W skład oprawy wchodzi wbudowana lampa LED  
 CZ: Toto svítidlo obsahuje zabudovaný světelný zdroj LED  
 SK: Toto svetidlo obsahuje zabudovaný svetelný zdroj LED



PL: Nie można wymieniać lampy w oprawie  
 CZ: Světelný zdroj v tomto svítidle nelze vyměnit  
 SK: Svetelný zdroj v svetidle sa neda vymeniť

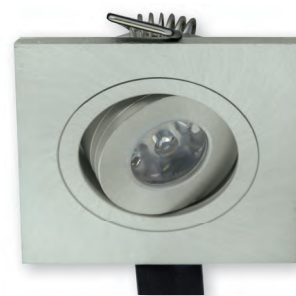
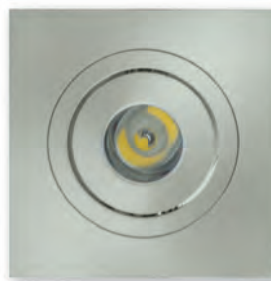
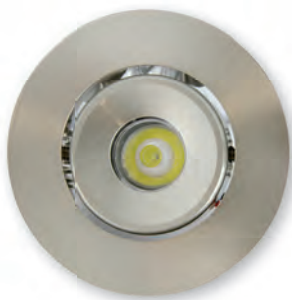

1 VERA-1 HL671L MATCHR 2700K

2 VERA-1 HL671L MATCHR 6400K

3 ELENA-1 HL670L MATCHR 2700K

4 ELENA-1 HL670L MATCHR 6400K

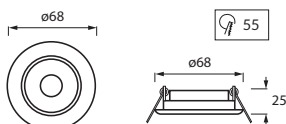

1 2 VERA-1 HL671L MATCHR

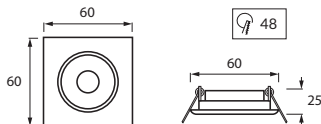

3 4 ELENA-1 HL670L MATCHR

Code	Part No.	Model	Material	Color	Temp. (K)	Part No.
1	01693	VERA-1 HL671L MATCHR 2700K	matowy chrom matný chrom	ciepłobiała / teplá biła / teplá biela	2700K	5901477316937
2	01694	VERA-1 HL671L MATCHR 6400K		zimnobiała / studená biła / studená biela	6500K	5901477316944
3	01691	ELENA-1 HL670L MATCHR 2700K	matný chróm	ciepłobiała / teplá biła / teplá biela	2700K	5901477316913
4	01692	ELENA-1 HL670L MATCHR 6400K		zimnobiała / studená biła / studená biela	6500K	5901477316920

⚡ 220-240V~	⌚ 1W	⚙️ POWER LED	💡 65lm
🌞	⚠️	📐 80°	🌱 [CRI] [Ra] >80
🕒 30000h	📡	IP 20	♻️
⚡ 0,5	⊠	CE	

🌐 **Materiał / Materiál / Materiál**

PL: odlew stopu aluminium

CZ: odlitek z hliníkové slitiny

SK: odliatok z hliníkovej zliatiny

⚠️ **Uwagi / Komentář / Komentáre**

PL: zasilacz w komplecie

CZ: napájecí zdroj je součástí dodávky

SK: napájací zdroj je súčasťou dodávky



PL: W skład oprawy wchodzi wbudowana lampa LED  
 CZ: Toto svítidlo obsahuje zabudovaný světelný zdroj LED  
 SK: Toto svietidlo obsahuje zabudovaný svetelný zdroj LED



PL: Nie można wymieniać lampy w oprawie  
 CZ: Světelný zdroj v tomto svítidle nelze vyměnit  
 SK: Svetelný zdroj v svietidle sa neda vymeniť

# VERA HL673L / ELENA HL672L

ideus

Sufitowa oprawa punktowa POWER LED

cz: Podhledové bodové svítidlo POWER LED / sk: Podhládové bodové svietidlo POWER LED



1 VERA-3 HL673L  
CHR+MATCHR 2700K

2 VERA-3 HL673L  
CHR+MATCHR 6400K

3 ELENA-3 HL672L  
CHR+MATCHR 2700K

4 ELENA-3 HL672L  
CHR+MATCHR 6400K

220-240V-	3 x 1W	POWER LED	327lm
80°	CRI >80	IP 20	
30000h			

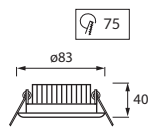
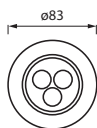

1 2 VERA-3 HL673L CHR+ MATCHR

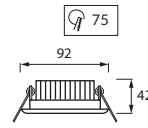
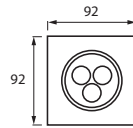

3 4 ELENA-3 HL672L CHR+ MATCHR

01234	ABCDE			Tc (K)		
1	01697	VERA-3 HL673L CHR+MATCHR 2700K	chrom+matowy chrom chrom+matný chrom chróm+matný chróm	ciepłobiała / teplá bílá / teplá biela	2700K	5901477316975
2	01698	VERA-3 HL673L CHR+MATCHR 6400K		zimnobiała / studená bílá / studená biela	6500K	5901477316982
3	01695	ELENA-3 HL672L CHR+MATCHR 2700K		ciepłobiała / teplá bílá / teplá biela	2700K	5901477316951
4	01696	ELENA-3 HL672L CHR+MATCHR 6400K		zimnobiała / studená bílá / studená biela	6500K	5901477316968

Materiał / Materiál / Material
PL: odlew stopu aluminium
CZ: odlitek z hliníkové slitiny
SK: odliatok z hliníkovej zliatiny
Uwagi / Komentář / Komentáre
PL: zasílacz w komplecie
CZ: napájecí zdroj je součástí dodávky
SK: napájací zdroj je súčasťou dodávky



PL: W skład oprawy wchodzi wbudowane lampy LED  
 CZ: Toto svítidlo obsahuje zabudované světelné zdroje LED  
 SK: Toto svietidlo obsahuje zabudované svetelné zdroje LED

PL: Nie można wymieniać lamp w oprawie  
 CZ: Světelné zdroje v tomto svítidle nelze vyměnit  
 SK: Svetelné zdroje v svietidle sa nedajú vymeniť





1 VERA-6 HL675L CHR+MATCHR 2700K



3 ELENA-6 HL674L CHR+MATCHR 2700K



5 VERA-12 HL676L CHR+MATCHR 2700K



2 VERA-6 HL675L CHR+MATCHR 6400K



4 ELENA-6 HL674L CHR+MATCHR 6400K



6 VERA-12 HL676L CHR+MATCHR 6400K

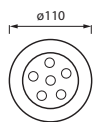

1 VERA-6 HL675L  
2 CHR+MATCHR

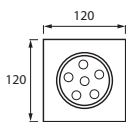
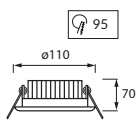

3 ELENA-6 HL674L  
4 CHR+MATCHR

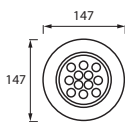
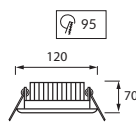

5 VERA-12 HL676L  
6 CHR+MATCHR

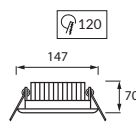

220-240V~	POWER LED	80°	CRI >80 [Ra]	30000h	IP 20
	0,5				

1	01234	ABCDE							
1	01701	VERA-6 HL675L CHR+MATCHR 2700K	6 x 1 W	721 lm	chrom+matowy chrom chrom+matny chrom chróm+matný chróm	ciepłobiała / ciepła biała / ciepła biela	2700K	✓	5901477317019
2	01702	VERA-6 HL675L CHR+MATCHR 6400K		876 lm		zimnobiała / studená biała / studená biela	6500K	✓	5901477317026
3	01699	ELENA-6 HL674L CHR+MATCHR 2700K		721 lm		ciepłobiała / ciepła biała / ciepła biela	2700K	✓	5901477316999
4	01700	ELENA-6 HL674L CHR+MATCHR 6400K		876 lm		zimnobiała / studená biała / studená biela	6500K	✓	5901477317002
5	01703	VERA-12 HL676L CHR+MATCHR 2700K	12 x 1 W	1215 lm	ciepłobiała / ciepła biała / ciepła biela	2700K	×	5901477317033	
6	01704	VERA-12 HL676L CHR+MATCHR 6400K		1494 lm	zimnobiała / studená biała / studená biela	6500K	×	5901477317040	

PL: W skład oprawy wchodzi wbudowane lampy LED  
 CZ: Toto svítidlo obsahuje zabudované světelné zdroje LED  
 SK: Toto svetidlo obsahuje zabudované svetelné zdroje LED

**LED**

LED LED A++ A+ A B C D E

PL: Nie można wymieniać lamp w oprawie  
 CZ: Světelné zdroje v tomto svítidle nelze vyměnit  
 SK: Svetelné zdroje v svetidle sa nedajú vymeniť



**Materiał / Materiál / Material**

PL: odlew stopu aluminium  
 CZ: odlitek z hliníkové slitiny  
 SK: odliatok z hliníkovej zliatiny

**Uwagi / Komentář / Kommentäre**

PL: zasilacz w komplecie  
 CZ: napájecí zdroj je součástí dodávky  
 SK: napájací zdroj je súčasťou dodávky

# LILYA HL698LE / LILYA HL699LE

ideus

Sufitowa oprawa punktowa COB LED

cz: Podhledové bodové svítidlo COB LED / sk: Podhľadové bodové svietidlo COB LED



1 LILYA-3 HL698LE 2700K



2 LILYA-3 HL698LE 6400K



3 LILYA-5 HL699LE 2700K



4 LILYA-5 HL699LE 6400K

220-240V~	COB LED		
80°	CRI >80	30000h	
IP 20		0,5	

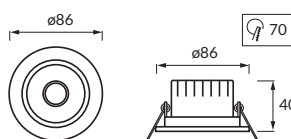

1...4 LILYA HL69xLE

	01234	ABCDE					Tc Kd S0Chs6	
1	02551	LILYA-3 HL698LE 2700K	3 W	222 lm	matowy chrom matny chrom matný chróm	ciepłobiała / teplá bilá / teplá biela	2700K	5901477325519
2	02550	LILYA-3 HL698LE 6400K				zimnobiała / studená bilá / studená biela	6500K	5901477325502
3	02553	LILYA-5 HL699LE 2700K	5 W	335 lm		ciepłobiała / teplá bilá / teplá biela	2700K	5901477325533
4	02552	LILYA-5 HL699LE 6400K				zimnobiała / studená bilá / studená biela	6500K	5901477325526

## Materiał / Materiál / Material

PL: aluminium, szkło  
CZ: hliník, sklo  
SK: hliník, sklo

## Uwagi / Komentář / Komentáre

PL: zasilacz w komplecie  
CZ: napájecí zdroj je součástí dodávky  
SK: napájací zdroj je súčasťou dodávky



PL: W skład oprawy wchodzi wbudowana lampa LED  
CZ: Toto svítidlo obsahuje zabudovaný světelný zdroj LED  
SK: Toto svietidlo obsahuje zabudovaný svetelný zdroj LED

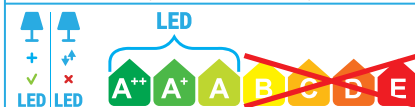

PL: Nie można wymieniać lampy w oprawie  
CZ: Světelný zdroj v tomto svítidle nelze vyměnit  
SK: Svetelný zdroj v svietidle sa neda vymeniť





1 VICTORIA-3 HL678L 2700K



2 VICTORIA-3 HL678L 6500K

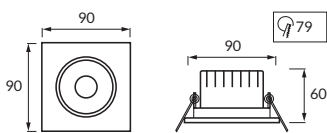

1 2 VICTORIA-3 HL678L

220-240V-	3W	COB LED	<input checked="" type="checkbox"/>
230 lm	80°	>80	[Ra]
40000h	IP	20	
0,5			

01234	ABCDE					
1	02264	VICTORIA-3 HL678L 2700K	matowy chrom matný chrom	ciepłobiała / teplá bílá / teplá biela	2700K	5901477322648
2	02265	VICTORIA-3 HL678L 6500K	matný chróm	zimnobiała / studená bílá / studená biela	6500K	5901477322655



<b>Materiał / Materiál / Material</b>
<i>PL:</i> odlew stopu aluminium, szkło
<i>CZ:</i> odlitek z hliníkové slitiny, sklo
<i>SK:</i> odliatok z hliníkovej zliatiny, sklo

<b>Uwagi / Komentář / Komentáře</b>
<i>PL:</i> zasílac w komplecie
<i>CZ:</i> napájecí zdroj je součástí dodávky
<i>SK:</i> napájací zdroj je súčasťou dodávky

**PL:** W skład oprawy wchodzi wbudowana lampa LED  
**CZ:** Toto svítidlo obsahuje zabudovaný světelný zdroj LED  
**SK:** Toto svietidlo obsahuje zabudovaný svetelný zdroj LED

**LED**

**PL:** Nie można wymieniać lampy w oprawie  
**CZ:** Světelný zdroj v tomto svítidle nelze vyměnit  
**SK:** Svetelný zdroj v svietidle sa neda vymeniť



# MILTON LED 6W

## Oprawa dekoracyjna SMD LED

cz: Dekorační SMD LED svítidlo / sk: Dekoračné SMD LED svietidlo



1 MILTON LED C 6W MATCHR 3000K

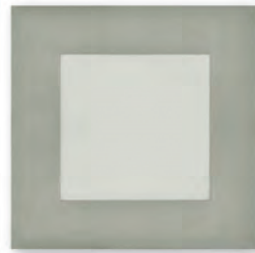

2 MILTON LED D 6W MATCHR 3000K



3 MILTON LED D 6W MATCHR 5700K



4 MILTON LED D 6W WHITE 3000K



5 MILTON LED D 6W WHITE 5700K

220-240V-	6W	SMD LED	120°
492lm	IP20	CRI >80	Ra >80
30000h	0,5		

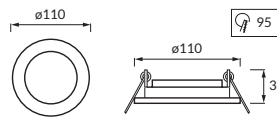

1 MILTON LED C 6W MATCHR 3000K

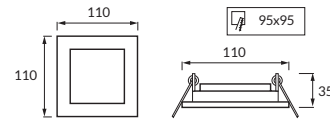

2 3 5 MILTON LED D 6W

Code	Model	Color	Temperature	Barcode		
1	02124	MILTON LED C 6W MATCHR 3000K	ciepłobiała / teplá bílá / teplá biela	3000K	5901477321245	
2	02120	MILTON LED D 6W MATCHR 3000K	matowy chrom / matný chrom / matný chróm	ciepłobiała / teplá bílá / teplá biela	3000K	5901477321207
3	02119	MILTON LED D 6W MATCHR 5700K	zimnobiała / studená bílá / studená biela	5700K	5901477321191	
4	02118	MILTON LED D 6W WHITE 3000K	biały / bílá / biely	ciepłobiała / teplá bílá / teplá biela	3000K	5901477321184
5	02117	MILTON LED D 6W WHITE 5700K	zimnobiała / studená bílá / studená biela	5700K	5901477321177	

<b>Materiał / Materiál / Material</b>
PL: odlew stopu aluminium, szkło akrylowe
CZ: odlitek z hliníkové slitiny, akrylové sklo
SK: odliatok z hliníkovej zliatiny, akrylátové sklo
<b>Uwagi / Komentář / Komentáre</b>
PL: zasílacz w komplecie
CZ: napájecí zdroj je součástí dodávky
SK: napájací zdroj je súčasťou dodávky



PL: W skład oprawy wchodzi wbudowane lampy LED  
 CZ: Toto svítidlo obsahuje zabudované světelné zdroje LED  
 SK: Toto svietidlo obsahuje zabudované svetelné zdroje LED

PL: Nie można wymieniać lamp w oprawie  
 CZ: Světelné zdroje v tomto svítidle nelze vyměnit  
 SK: Svetelné zdroje v svietidle sa nedajú vymeniť



1 MILTON LED C 12W MATCHR 3000K



2 MILTON LED D 12W MATCHR 3000K



3 MILTON LED D 12W MATCHR 5700K



4 MILTON LED D 12W WHITE 3000K



5 MILTON LED D 12W WHITE 5700K

220-240V~	12W	SMD LED	
1020lm	120°	>80	[Ra]
30000h	20		0,5

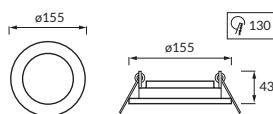

1 MILTON LED C 12W MATCHR 3000K

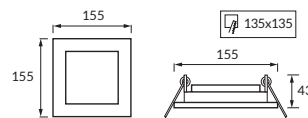

2...5 MILTON LED D 12W

1	01234	ABCDE				
1	02132	MILTON LED C 12W MATCHR 3000K				
2	02128	MILTON LED D 12W MATCHR 3000K	matowy chrom / matný chrom / matný chróm	ciepłobiała / teplá bílá / teplá biela	3000K	5901477321320
3	02127	MILTON LED D 12W MATCHR 5700K		zimnobiała / studená bílá / studená biela	5700K	5901477321276
4	02126	MILTON LED D 12W WHITE 3000K		ciepłobiała / teplá bílá / teplá biela	3000K	5901477321269
5	02125	MILTON LED D 12W WHITE 5700K	biały / bílá / biely	zimnobiała / studená bílá / studená biela	5700K	5901477321252

PL: W skład oprawy wchodzi wbudowane lampy LED  
 CZ: Toto svítidlo obsahuje zabudované světelné zdroje LED  
 SK: Toto svietidlo obsahuje zabudované svetelné zdroje LED

PL: Nie można wymieniać lamp w oprawie  
 CZ: Světelné zdroje v tomto svítidle nelze vyměnit  
 SK: Svetelné zdroje v svietidle sa nedajú vymeniť



- Materiał / Materiál / Material**  
 PL: odlew stopu aluminium, szkło akrylowe  
 CZ: odlitek z hliníkové slitiny, akrylové sklo  
 SK: odlatok z hliníkovej zliatiny, akrylátové sklo
- Uwagi / Komentář / Komentáre**  
 PL: zasilacz w komplecie  
 CZ: napájecí zdroj je součástí dodávky  
 SK: napájací zdroj je súčasťou dodávky

# SLIM-x HL563L

Oprawa typu downlight SMD LED

cz: Svítidlo typu „downlight” SMD LED / sk: Sviestidlo typu „downlight” SMD LED



3 4 SLIM-6 HL563L 6W



5 6 SLIM-9 HL563L 9W



7 8 SLIM-12 HL563L 12W



9 10 SLIM-15 HL563L 15W



11 12 SLIM-18 HL563L 18W



13 14 SLIM-24 HL563L 24W

1 2 SLIM-3 HL563L 3W

220-240V-	SMD LED		
120°	CRI >80	50000h	IP 20
	0,5		

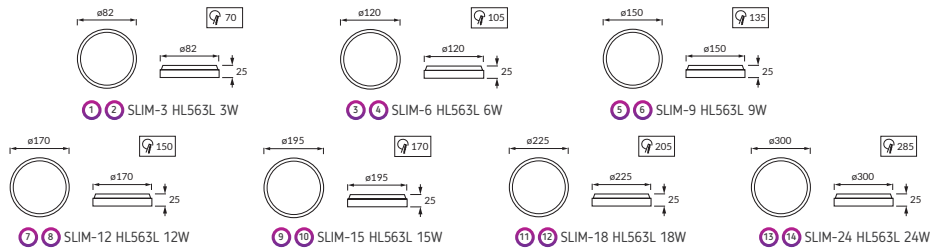

Model	Code	Material	Power (W)	Lumen (lm)	Color	Color Temperature (K)	Barcode
1	02808	SLIM-3 HL563L 3W WHITE 2700K	3 W	110 lm	ciepłobiała / teplá bílá / teplá biela	2700K	5901477328084
2	02809	SLIM-3 HL563L 3W WHITE 6400K			zimmnobiała / studená bílá / studená biela	6500K	5901477328091
3	02810	SLIM-6 HL563L 6W WHITE 2700K	6 W	270 lm	ciepłobiała / teplá bílá / teplá biela	2700K	5901477328107
4	02811	SLIM-6 HL563L 6W WHITE 6400K			zimmnobiała / studená bílá / studená biela	6500K	5901477328114
5	02483	SLIM-9 HL563L 9W WHITE 2700K	9 W	540 lm	ciepłobiała / teplá bílá / teplá biela	2700K	5901477324833
6	02484	SLIM-9 HL563L 9W WHITE 6400K			zimmnobiała / studená bílá / studená biela	6500K	5901477324840
7	02485	SLIM-12 HL563L 12W WHITE 2700K	12 W	660 lm	ciepłobiała / teplá bílá / teplá biela	2700K	5901477324857
8	02486	SLIM-12 HL563L 12W WHITE 6400K			zimmnobiała / studená bílá / studená biela	6500K	5901477324864
9	02812	SLIM-15 HL563L 15W WHITE 2700K	15 W	900 lm	ciepłobiała / teplá bílá / teplá biela	2700K	5901477328121
10	02813	SLIM-15 HL563L 15W WHITE 6400K			zimmnobiała / studená bílá / studená biela	6500K	5901477328138
11	02487	SLIM-18 HL563L 18W WHITE 2700K	18 W	1170 lm	ciepłobiała / teplá bílá / teplá biela	2700K	5901477324871
12	02488	SLIM-18 HL563L 18W WHITE 6400K			zimmnobiała / studená bílá / studená biela	6500K	5901477324888
13	02489	SLIM-24 HL563L 24W WHITE 2700K	24 W	1632 lm	ciepłobiała / teplá bílá / teplá biela	2700K	5901477324895
14	02490	SLIM-24 HL563L 24W WHITE 6400K			zimmnobiała / studená bílá / studená biela	6500K	5901477324901

**Materiał / Materiál / Material**  
 PL: odlew stopu aluminium, tworzywo sztuczne  
 CZ: odlitek z hliníkové slitiny, plast  
 SK: odliatok z hliníkovej zliatiny, plast

**Uwagi / Komentář / Komentáre**  
 PL: zasilacz w komplecie  
 CZ: napájecí zdroj je součástí dodávky  
 SK: napájací zdroj je súčasťou dodávky



PL: W skład oprawy wchodzi wbudowane lampy LED  
 CZ: Toto svítidlo obsahuje zabudované světelné zdroje LED  
 SK: Toto svietidlo obsahuje zabudované svetelné zdroje LED

PL: Nie można wymieniać lamp w oprawie  
 CZ: Světelné zdroje v tomto svítidle nelze vyměnit  
 SK: Svetelné zdroje v svietidle sa nedajú vymeniť





0,9w  
LED wiele kolorów  
LED viacfarebný  
LED viacfarbný

1 RIANA LED C CHROME RGB

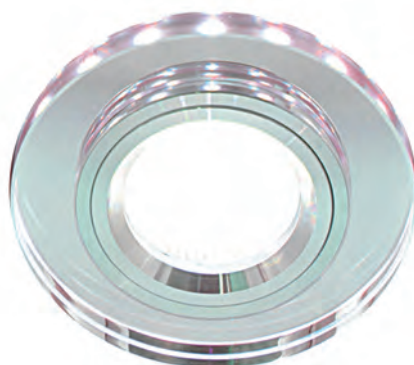

2 RIANA LED C CHROME 6500K



3 STAN LED D CHROME 6500K

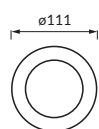

1 RIANA LED C CHROME RGB

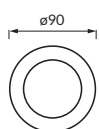
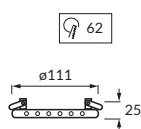

2 RIANA LED C CHROME 6500K

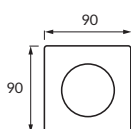
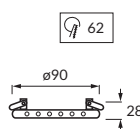

3 STAN LED D CHROME 6500K

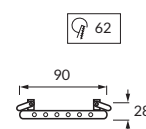

220-240V~	max 50W	GU10	GU10
IP 20		0,5	

CE

	01234	ABCDE		
1	02917	RIANA LED C CHROME RGB	przezroczysty+chrom průhledný+chrom priehľadný+chróm	5901477329173
2	02918	RIANA LED C CHROME 6500K		5901477329180
3	02919	STAN LED D CHROME 6500K		5901477329197



PL: Oprawa jest przystosowana do żarówek o klasach energetycznych:  
cz: Toto svítidlo je kompatibilní s žárovkami energetické třídy:  
sk: Toto svietidlo je kompatibilné so žiarovkami energetických tried:

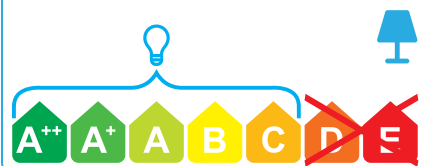

1 RIANA LED C CHROME RGB

**Uwagi / Komentář / Komentáre**

PL: w komplecie ozdobne diody SMD LED: 230V-, 0,9W, RGB (wiele kolorów), zasilacz  
cz: SMD LED je součástí dodávky: 230V-, 0,9W, RGB (viacfarebný), napájecí zdroj  
sk: SMD LED je súčasťou dodávky: 230V-, 0,9W, RGB (viacfarebný), napájací zdroj

2 RIANA LED C CHROME 6500K  
3 STAN LED D CHROME 6500K

**Uwagi / Komentář / Komentáre**

PL: w komplecie ozdobne diody SMD LED: 230V-, 1,1W, 6500K (zimnobiała), zasilacz  
cz: SMD LED je součástí dodávky: 230V-, 1,1W, 6500K (studená bílá), napájecí zdroj  
sk: SMD LED je súčasťou dodávky: 230V-, 1,1W, 6500K (studená biela), napájací zdroj

# RIANA / HANNA / STAN

ideus

Sufitowa oprawa punktowa

cz: Podhledové bodové svítidlo / sk: Pohľadové bodové svetidlo

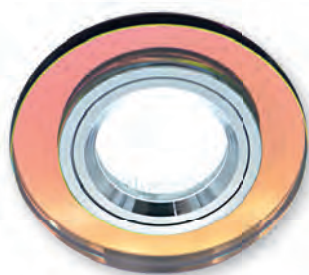

1 RIANA C MULTI



2 RIANA C CHROME



3 HANNA C CHROME



4 STAN D MULTI



5 STAN D CHROME

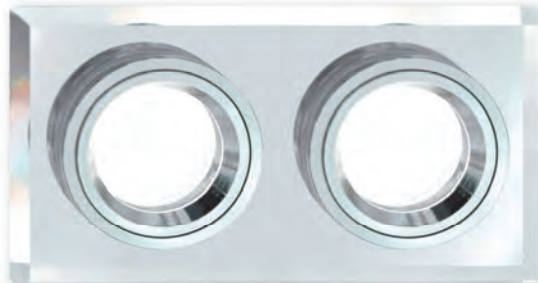

6 STAN L CHROME

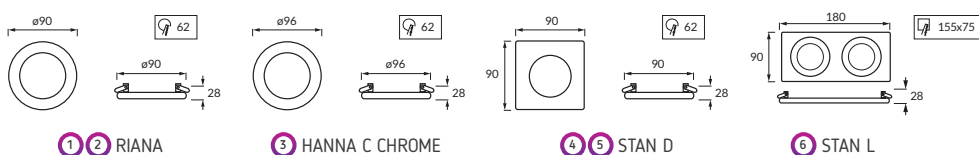
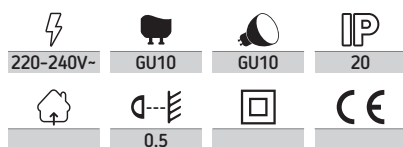

1	01234	ABCDE			
1	02920	RIANA C MULTI	max 50 W	przezroczysty+kameleon / průhledný+chameleón / priehľadný+chameleón	5901477329203
2	02921	RIANA C CHROME	max 50 W	przezroczysty+chrom / průhledný+chrom / priehľadný+chróm	5901477329210
3	02922	HANNA C CHROME	max 50 W	przezroczysty+chrom / průhledný+chrom / priehľadný+chróm	5901477329227
4	02925	STAN D MULTI	max 50 W	przezroczysty+kameleon / průhledný+chameleón / priehľadný+chameleón	5901477329258
5	02924	STAN D CHROME	max 50 W	przezroczysty+chrom / průhledný+chrom / priehľadný+chróm	5901477329241
6	03095	STAN L CHROME	2 x max 50 W	przezroczysty+chrom / průhledný+chrom / priehľadný+chróm	5901477330957

**Materiál / Materiál / Materiál**  
 PL: odlew stopu aluminium, szkło  
 cz: odlitek z glinikowej slitiny, szkło  
 sk: odliatok z hliníkovej zliatiny, szkło



PL: Oprawa jest przystosowana do żarówek o klasach energetycznych:  
 cz: Toto svítidlo je kompatibilní s žárovkami energetické třídy:  
 sk: Toto svetidlo je kompatibilné so žiarovkami energetických tried:

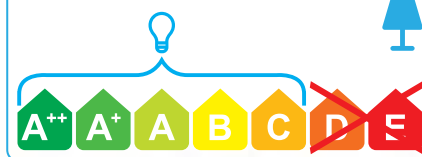





1 NERGIS HL801 CLEAR



2 NERGIS HL801 BROWN



3 NUFER HL800 CLEAR



4 NUFER HL800 BROWN

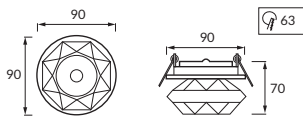

1 2 NERGIS HL801

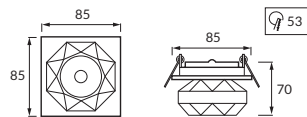

3 4 NUFER HL800

12V	max 20W	G4	JC
IP 20		0,5	

	01234	ABCDE		
1	01341	NERGIS HL801 CLEAR	przezroczysty / průhledný / priehľadný	5901477313417
2	01343	NERGIS HL801 BROWN	brązowy / hnědá / hnedý	5901477313431
3	01336	NUFER HL800 CLEAR	przezroczysty / průhledný / priehľadný	5901477313363
4	01338	NUFER HL800 BROWN	brązowy / hnědá / hnedý	5901477313387

<b>Materiał / Materiál / Material</b>
PL: szkło
cz: sklo
sk: sklo



PL: Oprawa jest przystosowana do żarówek o klasach energetycznych:  
 cz: Toto svítidlo je kompatibilní s žárovkami energetické třídy:  
 sk: Toto svietidlo je kompatibilné so žiarovkami energetických tried:

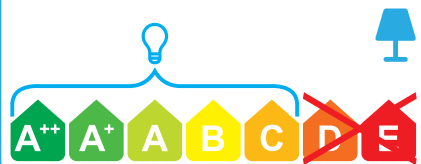



# ALUM

ideus

## Sufitowa oprawa punktowa

cz: Podhledové bodové svítidlo / sk: Podhľadové bodové svietidlo



1 ALUM C SILVER



2 ALUM D SILVER



3 ALUM L SILVER

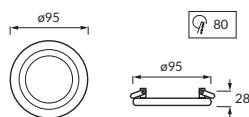
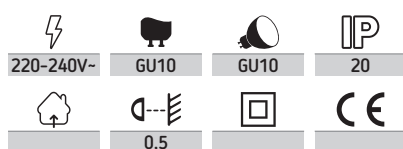

1 ALUM C SILVER

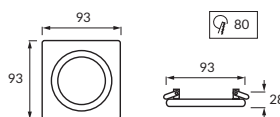

2 ALUM D SILVER

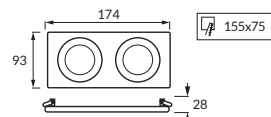

3 ALUM L SILVER

### Materiał / Materiál / Material

PL: odlew stopu aluminium

CZ: odlitek z hliníkové slitiny

SK: odliatok z hliníkovej zliatiny

	01234	ABCDE				
1	03096	ALUM C SILVER	max 50 W	srebrny stříbrná strieborná	×	5901477330964
2	03097	ALUM D SILVER	max 50 W		✓	5901477330971
3	03098	ALUM L SILVER	2 x max 50 W	✓	5901477330988	



PL: Oprawa jest przystosowana do żarówek o klasach energetycznych:

CZ: Toto svítidlo je kompatibilní s žárovkami energetické třídy:

SK: Toto svietidlo je kompatibilné so žiarovkami energetických tried:

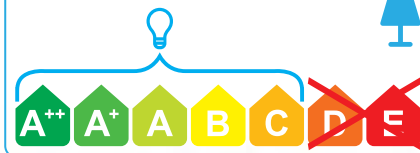



1 BORYS D SILVER



2 BORYS L SILVER

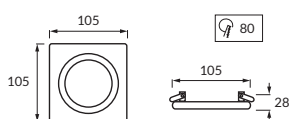

1 BORYS D SILVER

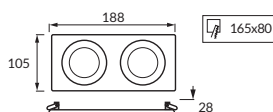

2 BORYS L SILVER

220-240V~	GU10	GU10	
IP 20		0,5	

CE

1	01234	03139	BORYS D SILVER	max 50 W	srebrny+czarny stříbrná+černá 5901477331398
2	03140	BORYS L SILVER	2 x max 50 W	strieborná+čierna 5901477331404	

**Materiał / Materiál / Material**

PL: odlew stopu aluminium, tworzywo sztuczne

cz: odlitek z hliníkové slitiny, plast

sk: odliatok z hliníkovej zliatiny, plast



PL: Oprawa jest przystosowana do żarówek o klasach energetycznych:

cz: Toto svítidlo je kompatibilní s žárovkami energetické třídy:

sk: Toto svietidlo je kompatibilné so žiarovkami energetických tried:

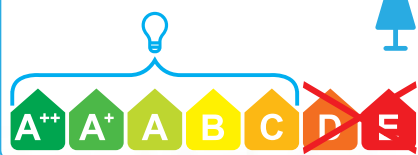

# ORKIDE HL750

Sufitowa oprawa punktowa

cz: Podhledové bodové svítidlo / sk: Podhľadové bodové svietidlo



1 ORKIDE HL750 CHROME



3 ORKIDE HL750 GOLDEN



2 ORKIDE HL750 MATCHR



4 ORKIDE HL750 WHITE

12V	max 50W	GU5.3	MR16
	IP 20		0,5

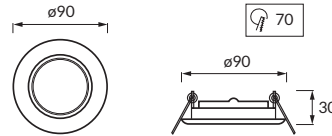

1...4 ORKIDE HL750

<b>Materiał / Materiál / Material</b>
PL: blacha stalowa
CZ: kovový výlisek
SK: kovový výlisok

<b>Uwagi / Komentář / Kommentäre</b>
2 szt. w opakowaniu jednostkowym; PL: cena podawana jest za jedno opakowanie (tj. za dwie sztuki)
CZ: 2 produkty v balení; cena za jeden balíček (dva kusy)
SK: 2 produkty v balení; cena za jeden balíček (dva kusy)

	01234	ABCDE		
1	01209	ORKIDE HL750 CHROME	chrom / chrom / chróm	5901477312090
2	01210	ORKIDE HL750 MATCHR	matowy chrom / matný chrom / matný chróm	5901477312106
3	01208	ORKIDE HL750 GOLDEN	złoty / zlatá / zlatá	5901477312083
4	01207	ORKIDE HL750 WHITE	biały / bílá / biely	5901477312076



PL: Oprawa jest przystosowana do żarówek o klasach energetycznych:  
CZ: Toto svítidlo je kompatibilní s žárovkami energetické třídy:  
SK: Toto svietidlo je kompatibilné so žiarovkami energetických tried:

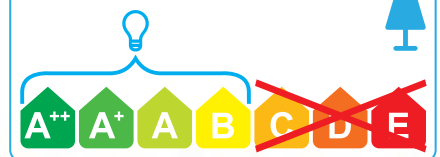





1 MENEKSE HL752 CHROME



2 MENEKSE HL752 MATCHR



3 MENEKSE HL752 GOLDEN



4 MENEKSE HL752 RED COPPER



5 MENEKSE HL752 GREY



6 MENEKSE HL752 WHITE

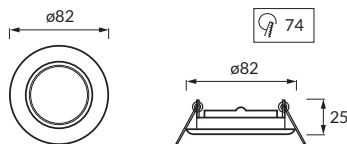

1...6 MENEKSE HL752

12V	max 50W	GU5.3	MR16
	IP 20		0,5

	01234	ABCDE		
1	01218	MENEKSE HL752 CHROME	chrom / chrom / chróm	5901477312182
2	01219	MENEKSE HL752 MATCHR	matowy chrom / matný chrom / matný chróm	5901477312199
3	01217	MENEKSE HL752 GOLDEN	złoty / zlatá / zlatá	5901477312175
4	01220	MENEKSE HL752 RED COPPER	miedziany / měděný / medený	5901477312205
5	01216	MENEKSE HL752 GREY	szary / šedá / šedá	5901477312168
6	01215	MENEKSE HL752 WHITE	biały / bílá / biely	5901477312151

**Materiál / Material / Materiál**

PL: odlew stopu aluminium

cz: odlitek z hliníkové slitiny

sk: odliatok z hliníkovej zliatiny

PL: Oprawa jest przystosowana do żarówek o klasach energetycznych:

cz: Toto svítidlo je kompatibilní s žárovkami energetické třídy:

sk: Toto svietidlo je kompatibilné so žiarovkami energetických tried:

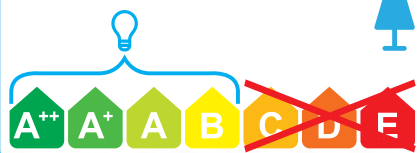

# ORTANCA HL755

ideus

Sufitowa oprawa punktowa

cz: Podhledové bodové svítidlo / sk: Podhladové bodové svetidlo



1 ORTANCA HL755 CHROME



2 ORTANCA HL755 MATCHR

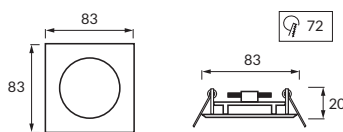
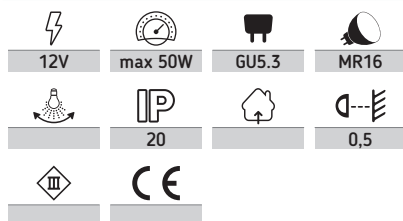

1 2 ORTANCA HL755

**Materiał / Materiál / Material**

PL: odlew stopu aluminium

CZ: odlitek z hliníkové slitiny

SK: odliatok z hliníkovej zliatiny

	01234	ABCDE		
1	01231	ORTANCA HL755 CHROME	chrom / chrom / chróm	5901477312311
2	01232	ORTANCA HL755 MATCHR	matowy chrom / matný chrom / matný chróm	5901477312328



PL: Oprawa jest przystosowana do żarówek o klasach energetycznych:  
 CZ: Toto svítidlo je kompatibilní s žárovkami energetické třídy:  
 SK: Toto svetidlo je kompatibilné so žiarovkami energetických tried:

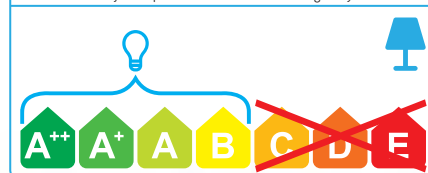





1 BEGONYA HL779  
CHROME



2 BEGONYA HL779  
MATCHR



3 BEGONYA HL779  
GOLDEN



4 BEGONYA HL779  
ANTIQUÉ GREEN



5 BEGONYA HL779  
ANTIQUÉ RED COPPER



6 BEGONYA HL779  
PEARL SILVER/GOLDEN



7 BEGONYA HL779  
TITANIUM BLACK/GOLDEN

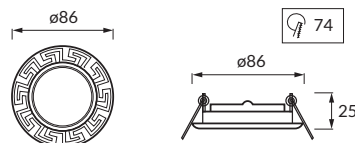

1...7 BEGONYA HL779

12V	max 50W	GU5.3	MR16
	IP 20		0,5

	01234	ABCDE		
1	01314	BEGONYA HL779 CHROME	chrom / chrom / chróm	5901477313141
2	01315	BEGONYA HL779 MATCHR	matowy chrom / matný chrom / matný chróm	5901477313158
3	01313	BEGONYA HL779 GOLDEN	złoty / zlatá / zlatá	5901477313134
4	01316	BEGONYA HL779 ANTIQUE GREEN	matowy mosiądz / matná mosaz / matná mosadz	5901477313165
5	01317	BEGONYA HL779 ANTIQUE RED COPPER	miedziany / měděný / medený	5901477313172
6	01318	BEGONYA HL779 PEARL SILVER/GOLDEN	perłowo srebrny+złoty / perleťově stříbrná+zlatá / perleťovo strieborná+zlatá	5901477313189
7	01319	BEGONYA HL779 TITANIUM BLACK/GOLDEN	czarny+złoty / černá+zlatá / čierna+zlatá	5901477313196



**Materiał / Materiál / Materiál**

PL: odlew stopu aluminium

CZ: odlitek z hliníkové slitiny

SK: odliatok z hliníkovej zliatiny

PL: Oprawa jest przystosowana do żarówek o klasach energetycznych:

CZ: Toto světlo je kompatibilní s žárovkami energetické třídy:

SK: Toto svetidlo je kompatibilné so žiarovkami energetických tried:

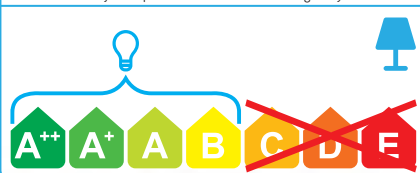



# ALFI LED / ANGELA HL761L

## Oprawa dekoracyjna LED

**CZ:** Dekorační LED svítidlo / **SK:** Dekoračné LED svetidlo



① ALFI LED C 3,5W SILVER 4000K

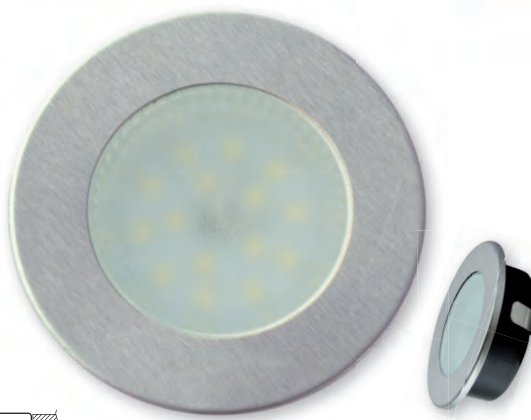

② ANGELA HL761L MATCHR 4200K

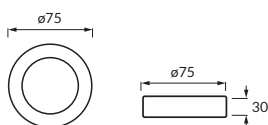
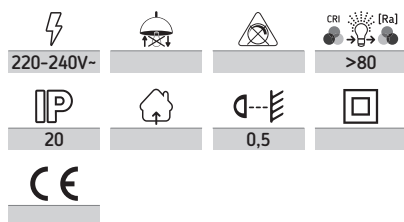

① ALFI LED C 3,5W SILVER 4000K

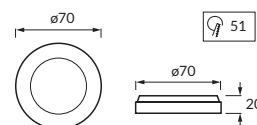

② ANGELA HL761L MATCHR 4200K

	01234	ABCDE									
1	03099	ALFI LED C 3,5W SILVER 4000K	3,5W	srebrny sřtřibná střieborná	COB LED	neutralna biela neutrální bílá neutrálna biela	4000K	255 lm	90°	30000h	5901477330995
2	02498	ANGELA HL761L MATCHR 4200K	2 W	matowy chrom matný chrom matný chróm	SMD LED		4200K	100 lm	30°	10000h	5901477324987

① ALFI LED C 3,5W SILVER 4000K

**Materiał / Materiál / Material**

PL: blacha stalowa, szkło

CZ: kovový výlisek, sklo

SK: kovový výlisek, sklo

② ANGELA HL761L MATCHR 6400K

**Materiał / Materiál / Material**

PL: odlew stopu aluminium, tworzywo sztuczne

CZ: odlitek z hliníkové slitiny, plast

SK: odliatok z hliníkovej zliatiny, plast

① ALFI LED C 3,5W SILVER 4000K

② ANGELA HL761L MATCHR 6400K

**Uwagi / Komentář / Kommentäre**

PL: zasilacz w komplecie

CZ: napájecí zdroj je součástí dodávky

SK: napájací zdroj je súčasťou dodávky



PL: W skład oprawy wchodzi wbudowane lampy LED  
 CZ: Toto svítidlo obsahuje zabudované světelné zdroje LED  
 SK: Toto svetidlo obsahuje zabudované svetelné zdroje LED

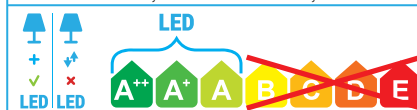

PL: Nie można wymieniać lamp w oprawie  
 CZ: Světelné zdroje v tomto svítidle nelze vyměnit  
 SK: Svetelné zdroje v svetidle sa nedajú vymeniť



# RAFI LED

## Oprawa dekoracyjna POWER LED

cz: Dekorační POWER LED svítidlo / sk: Dekoračné POWER LED svietidlo

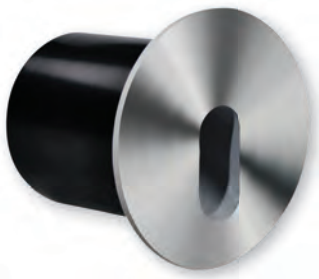

1 RAFI LED C  
3W MAT CHROME 4000K



2 RAFI LED C  
3W WHITE 4000K



3 RAFI LED D  
3W MAT CHROME 4000K



4 RAFI LED D  
3W WHITE 4000K

220-240V-	3W	POWER LED	
	4000K	210 lm	45°
>80	25000h	44	
0,5			

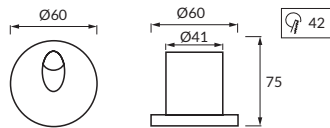

1 2 RAFI LED C

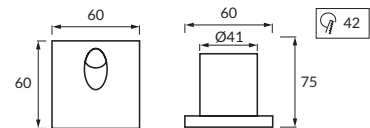

3 4 RAFI LED D

	<b>Materiał / Materiál / Material</b>
PL:	odlew stopu aluminium
CZ:	odlitek z hliníkové slitiny
SK:	odliatok z hliníkovej zliatiny

	<b>Uwagi / Komentář / Komentäre</b>
PL:	zasilacz w komplecie
CZ:	napájecí zdroj je součástí dodávky
SK:	napájací zdroj je súčasťou dodávky

1	03118	RAFI LED C 3W MAT CHROME 4000K	matowy chrom / matný chrom / matný chróm	5901477331183
2	03117	RAFI LED C 3W WHITE 4000K	biały / bílá / biely	5901477331176
3	03120	RAFI LED D 3W MAT CHROME 4000K	matowy chrom / matný chrom / matný chróm	5901477331206
4	03119	RAFI LED D 3W WHITE 4000K	biały / bílá / biely	5901477331190

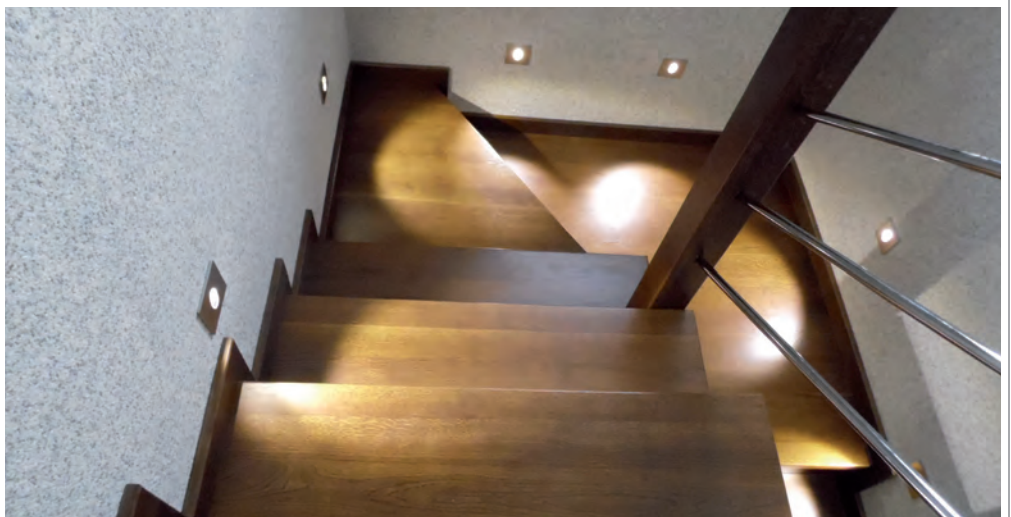

PL: W skład oprawy wchodzi wbudowana lampa LED  
 CZ: Toto svítidlo obsahuje zabudovaný světelný zdroj LED  
 SK: Toto svietidlo obsahuje zabudovaný svetelný zdroj LED

PL: Nie można wymieniać lampy w oprawie  
 CZ: Světelný zdroj v tomto svítidle nelze vyměnit  
 SK: Svetelný zdroj v svietidle sa neda vymeniť





1 KRISTAL LED WHITE



2 GOLD LED 6400K

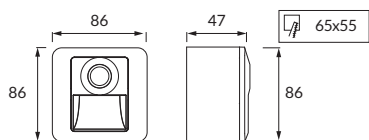

1 KRISTAL LED WHITE

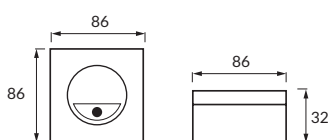

2 GOLD LED 6400K

220-240V~	SMD LED		
4000K	PIR	120°	>80
30000h	20		0,5

	01234	ABCDE					
1	02935	KRISTAL LED WHITE	1 W	65 lm	biały	neutralna biała	5901477329357
2	03004	GOLD LED 6400K	3 W	240 lm	biłá biely	neutrální bílá neutrálna biela	5901477330049

<b>Materiał / Materiál / Material</b>
PL: tworzywo sztuczne
CZ: plast
SK: plast

**Uwagi / Komentář / Komentáre**  
 PL: zasilacz w komplecie  
 CZ: napájecí zdroj je součástí dodávky  
 SK: napájací zdroj je súčasťou dodávky

**Uwagi / Komentář / Komentáre**  
 PL: zasięg wykrywania ruchu max 3m (<24°C)  
 CZ: maximální dosah čidla 3m (<24°C)  
 SK: maximálny dosah čidla 3m (<24°C)

**Uwagi / Komentář / Komentáre**  
 PL: kąt działania czujnika 130°  
 CZ: rozsah čidla pohybu 130°  
 SK: uhol činnosti pohybového čidla 130°

1 KRISTAL LED WHITE  
**Uwagi / Komentář / Komentáre**  
 PL: działa przy świetle otoczenia poniżej 2lx  
 CZ: působí na okolní světlo pod 2lx  
 SK: pôsobí na okolité svetlo pod 2lx

2 GOLD LED 6400K  
**Uwagi / Komentář / Komentáre**  
 PL: wyłączenie po 20s bez ruchu  
 CZ: doba svícení 20s  
 SK: doba svietenia 20s

1 KRISTAL LED WHITE  
**Uwagi / Komentář / Komentáre**  
 PL: wyłączenie po 45s bez ruchu  
 CZ: doba svícení 45s  
 SK: doba svietenia 45s

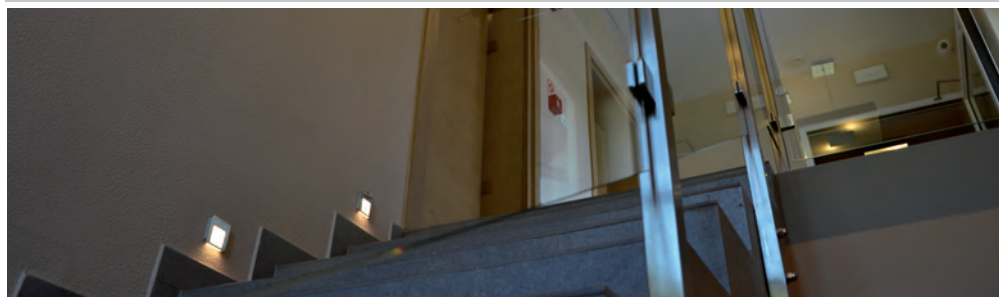

PL: W skład oprawy wchodzi wbudowane lampy LED  
 CZ: Toto svítidlo obsahuje zabudované světelné zdroje LED  
 SK: Toto svietidlo obsahuje zabudované svetelné zdroje LED

PL: Nie można wymieniać lamp w oprawie  
 CZ: Světelné zdroje v tomto svítidle nelze vyměnit  
 SK: Svetelné zdroje v svietidle sa nedajú vymeniť

# ROLEN LED

## Plafoniera SMD LED

cz: Plafon SMD LED / sk: Plafón SMD LED



1 ROLEN LED 3W 4000K

2 ROLEN LED 7W 4000K

3 ROLEN LED 10W 4000K

4 ROLEN LED 15W 4000K

220-240V~	SMD LED		
4000K	140°	>80	30000h
20		0,5	
<b>CE</b>			

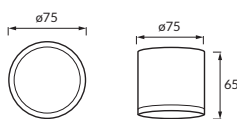

1 ROLEN LED 3W 4000K

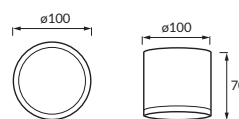

2 ROLEN LED 7W 4000K

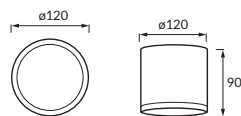

3 ROLEN LED 10W 4000K

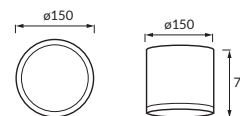

4 ROLEN LED 15W 4000K

### Materiał / Materiál / Material

PL: odlew stopu aluminium

CZ: odlitek z hliníkové slitiny

SK: odliatok z hliníkovej zliatiny

### Uwagi / Komentář / Komentáre

PL: zasílacz w komplecie

CZ: napájecí zdroj je součástí dodávky

SK: napájací zdroj je súčasťou dodávky

1	03107	ROLEN LED 3W 4000K	3W	240 lm	biały biłá biely	neutralna biela neutrálňi biłá neutrálna biela	5901477331077
2	03108	ROLEN LED 7W 4000K	7W	580 lm			5901477331084
3	03109	ROLEN LED 10W 4000K	10W	840 lm			5901477331091
4	03110	ROLEN LED 15W 4000K	15W	1330 lm			5901477331107



PL: W skład oprawy wchodzi wbudowane lampy LED

CZ: Toto svítidlo obsahuje zabudované světelné zdroje LED

SK: Toto svietidlo obsahuje zabudované svetelné zdroje LED

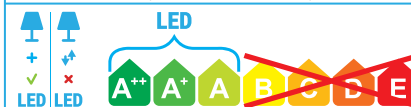

PL: Nie można wymieniać lamp w oprawie

CZ: Světelné zdroje v tomto svítidle nelze vyměnit

SK: Svetelné zdroje v svietidle sa nedajú vymeniť



1 GUSTI LED 3W 4000K



2 GUSTI LED 7W 4000K



3 GUSTI LED 10W 4000K

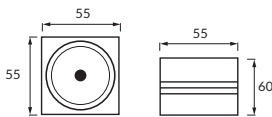

1 GUSTI LED 3W 4000K

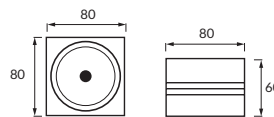

2 GUSTI LED 7W 4000K

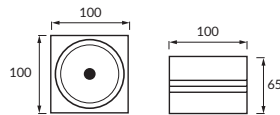

3 GUSTI LED 10W 4000K

220-240V~	COB LED		
4000K	120°	CRI >80	30000h
IP 20		0,5	

CE

Image	Code	Model	Power	Lumen	Finish	Color	Barcode
	01234	ABCDE					
1	03104	GUSTI LED 3W 4000K	3W	270 lm	srebrny	neutralna biała	5901477331046
2	03105	GUSTI LED 7W 4000K	7W	630 lm	stříbrná	neutrální bílá	5901477331053
3	03106	GUSTI LED 10W 4000K	10W	900 lm	stieborná	neutrálna biela	5901477331060



<b>Materiał / Materiál / Material</b>
PL: odlew stopu aluminium
CZ: odlitek z hliníkové slitiny
SK: odliatok z hliníkovej zliatiny
<b>Uwagi / Komentář / Komentáre</b>
PL: zasilacz w komplecie
CZ: napájecí zdroj je součástí dodávky
SK: napájací zdroj je súčasťou dodávky

PL: W skład oprawy wchodzi wbudowana lampa LED  
 CZ: Toto svítidlo obsahuje zabudovaný světelný zdroj LED  
 SK: Toto svietidlo obsahuje zabudovaný svetelný zdroj LED



PL: Nie można wymieniać lampy w oprawie  
 CZ: Světelný zdroj v tomto svítidle nelze vyměnit  
 SK: Svetelný zdroj v svietidle sa neda vymeniť



# IGOR LED



## Plafoniera SMD LED

cz: Plafon SMD LED / sk: Plafón SMD LED



1 IGOR LED C  
6W WHITE 4000K



2 IGOR LED C  
9W WHITE 4000K



3 IGOR LED D  
6W WHITE 4000K



4 IGOR LED D  
9W WHITE 4000K

220-240V-	COB LED		
TM21 SOLM85	CRI >80	30000h	
IP 20		0,5	
<b>CE</b>			

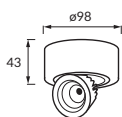

1 IGOR LED C  
6W WHITE 4000K

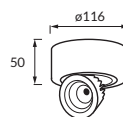

2 IGOR LED C  
9W WHITE 4000K

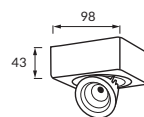

3 IGOR LED D  
6W WHITE 4000K

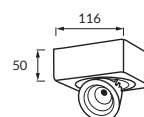

4 IGOR LED D  
9W WHITE 4000K

**Materiał / Materiál / Material**  
 PL: odlew stopu aluminium  
 CZ: odlitek z hliníkové slitiny  
 SK: odliatok z hliníkovej zliatiny

**Uwagi / Komentář / Kommentäre**  
 PL: zasilacz w komplecie  
 CZ: napájecí zdroj je součástí dodávky  
 SK: napájací zdroj je súčasťou dodávky

1	03125	IGOR LED C 6W WHITE 4000K	6W	500 lm			45°	5901477331251
2	03126	IGOR LED C 9W WHITE 4000K	9W	750 lm	biały	neutralna biała	65°	5901477331268
3	03127	IGOR LED D 6W WHITE 4000K	6W	500 lm	biela	neutrální bílá	45°	5901477331275
4	03128	IGOR LED D 9W WHITE 4000K	9W	750 lm	biely	neutrálna biała	65°	5901477331282



PL: W skład oprawy wchodzi wbudowane lampy LED  
 CZ: Toto svítidlo obsahuje zabudované světelné zdroje LED  
 SK: Toto svietidlo obsahuje zabudované svetelné zdroje LED

**LED**

PL: Nie można wymieniać lamp w oprawie  
 CZ: Světelné zdroje v tomto svítidle nelze vyměnit  
 SK: Svetelné zdroje v svietidle sa nedajú vymeniť



1 ALDEN LED C 3W+3W 4000K



2 ALDEN LED C 6W+3W 4000K



3 ALDEN LED C 12W+4W 4000K



4 ALDEN LED D 3W+3W 4000K



5 ALDEN LED D 6W+3W 4000K



6 ALDEN LED D 12W+4W 4000K

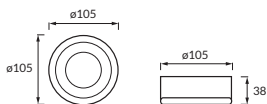

1 ALDEN LED C 3W+3W 4000K

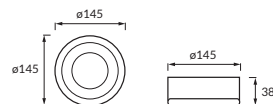

2 ALDEN LED C 6W+3W 4000K

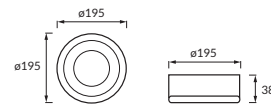

3 ALDEN LED C 12W+4W 4000K

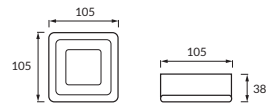

4 ALDEN LED D 3W+3W 4000K

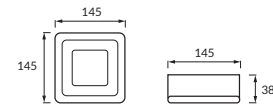

5 ALDEN LED D 6W+3W 4000K

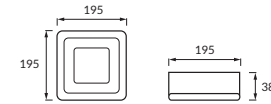

6 ALDEN LED D 12W+4W 4000K

220-240V~	SMD LED		
Tc(K) 4000K	140°	CRI >80	30000h
IP 42		0,5	

	01234					
1	02898	ALDEN LED C 3W+3W 4000K	3 W + 3 W	270 lm	biały biła biely	5901477328985
2	02899	ALDEN LED C 6W+3W 4000K	6 W + 3 W	540 lm		5901477328992
3	02900	ALDEN LED C 12W+4W 4000K	12 W + 4 W	1080 lm		5901477329005
4	02901	ALDEN LED D 3W+3W 4000K	3 W + 3 W	270 lm		5901477329012
5	02902	ALDEN LED D 6W+3W 4000K	6 W + 3 W	540 lm		5901477329029
6	02903	ALDEN LED D 12W+4W 4000K	12 W + 4 W	1080 lm		5901477329036

PL: W skład oprawy wchodzi wbudowane lampy LED  
 CZ: Toto svítidlo obsahuje zabudované světelné zdroje LED  
 SK: Toto svietidlo obsahuje zabudované svetelné zdroje LED

PL: Nie można wymieniać lamp w oprawie  
 CZ: Světelné zdroje v tomto svítidle nelze vyměnit  
 SK: Svetelné zdroje v svietidle sa nedajú vymeniť



- Materiał / Materiál / Material**  
 PL: odlew stopu aluminium, szkło akrylowe  
 CZ: odlitek z hliníkové slitiny, akrylové sklo  
 SK: odliatok z hliníkovej zliatiny, akrylátové sklo
- Uwagi / Komentář / Komentáre**  
 PL: zasilacz w komplecie  
 CZ: napájecí zdroj je součástí dodávky  
 SK: napájací zdroj je súčasťou dodávky
- Uwagi / Komentář / Komentáre**  
 PL: ramka świeci na niebiesko  
 CZ: rámeček svítí modře  
 SK: rámček svieti modro
- Uwagi / Komentář / Komentáre**  
 PL: możliwość włączenia światła białego lub niebieskiego lub jednocześnie białego i niebieskiego  
 CZ: možnost zapnutí bílé světlo, modré světlo nebo obojí, modré i bílé  
 SK: možnosť zapnúť biele svetlo, modré svetlo alebo oboje, modré aj biele

# ROBIN LED



## Plafoniera SMD LED

cz: Plafon SMD LED / sk: Plafón SMD LED



1 ROBIN LED C 6W 4000K

6 ROBIN LED D 12W 4000K



2 ROBIN LED C 12W 4000K



4 ROBIN LED C 24W 4000K



7 ROBIN LED D 18W 4000K



3 ROBIN LED C 18W 4000K



5 ROBIN LED D 6W 4000K



8 ROBIN LED D 24W 4000K

220-240V~	SMD LED		
4000K	140°	>80	30000h
IP 20		0,5	

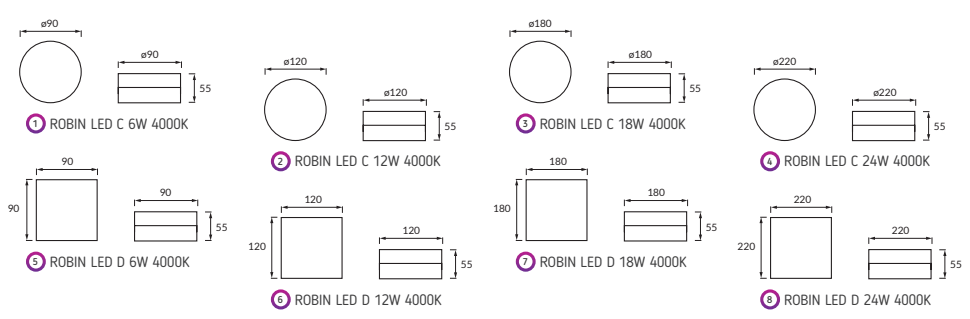

**Materiał / Materiál / Material**  
 PL: stal, tworzywo sztuczne  
 CZ: ocel, plast  
 SK: ocel, plast

**Uwagi / Komentář / Komentáre**  
 PL: zasilacz w komplecie  
 CZ: napájecí zdroj je součástí dodávky  
 SK: napájací zdroj je súčasťou dodávky

	01234	ABCDE					
1	03085	ROBIN LED C 6W 4000K	6 W	540 lm	biały biłá biely	neutralna biła neutrálná biłá neutrálna biela	5901477330858
2	03086	ROBIN LED C 12W 4000K	12 W	1080 lm			5901477330865
3	03087	ROBIN LED C 18W 4000K	18 W	1620 lm			5901477330872
4	03088	ROBIN LED C 24W 4000K	24 W	2160 lm			5901477330889
5	03089	ROBIN LED D 6W 4000K	6 W	540 lm			5901477330896
6	03090	ROBIN LED D 12W 4000K	12 W	1080 lm			5901477330902
7	03091	ROBIN LED D 18W 4000K	18 W	1620 lm			5901477330919
8	03092	ROBIN LED D 24W 4000K	24 W	2160 lm			5901477330926

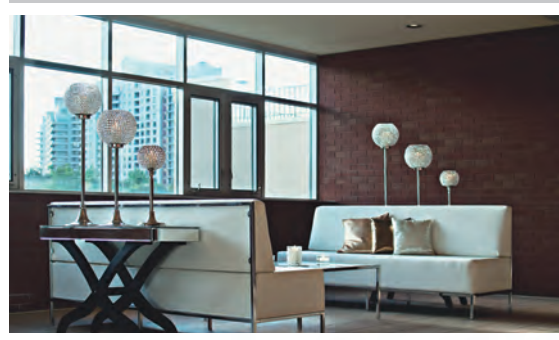

PL: W skład oprawy wchodzi wbudowane lampy LED  
 CZ: Toto svítidlo obsahuje zabudované světelné zdroje LED  
 SK: Toto svietidlo obsahuje zabudované svetelné zdroje LED

PL: Nie można wymieniać lamp w sprawie  
 CZ: Světelné zdroje v tomto svítidle nelze vyměnit  
 SK: Svetelné zdroje v svietidle sa nedajú vymeniť





1 MARTIN LED C 6W 4000K



2 MARTIN LED C 12W 4000K



3 MARTIN LED C 18W 4000K



4 MARTIN LED C 24W 4000K



5 MARTIN LED D 6W 4000K



6 MARTIN LED D 12W 4000K



7 MARTIN LED D 18W 4000K



8 MARTIN LED D 24W 4000K

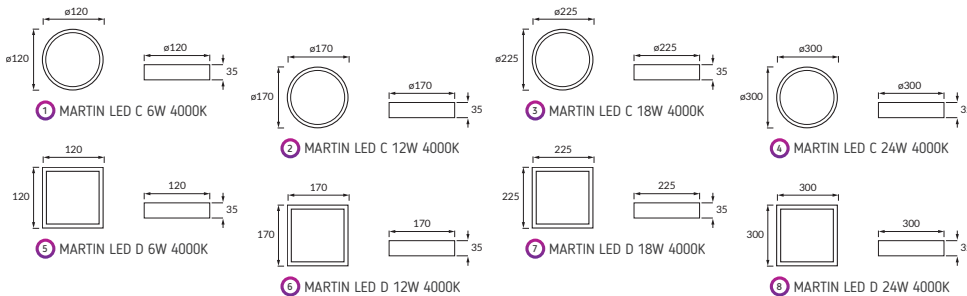

220-240V~	SMD LED		
Tc (K) 5000	4000K	CR1 [Ra]	30000h
IP 20		0,5	

Model	Code	Name	Power	Lumen	Color	Color	Barcode
1	02904	MARTIN LED C 6W 4000K	6 W	540 lm	biały biłá biely	neutralna biłá neutráltní biłá neutrálna biela	5901477329043
2	02905	MARTIN LED C 12W 4000K	12 W	1080 lm			5901477329050
3	02906	MARTIN LED C 18W 4000K	18 W	1620 lm			5901477329067
4	02907	MARTIN LED C 24W 4000K	24 W	2160 lm			5901477329074
5	02908	MARTIN LED D 6W 4000K	6 W	540 lm			5901477329081
6	02909	MARTIN LED D 12W 4000K	12 W	1080 lm			5901477329098
7	02910	MARTIN LED D 18W 4000K	18 W	1620 lm			5901477329104
8	02911	MARTIN LED D 24W 4000K	24 W	2160 lm			5901477329111

**Materiał / Materiál / Material**

PL: stal, tworzywo sztuczne  
 cz: ocel, plast  
 sk: ocel, plast

**Uwagi / Komentář / Komentáre**

PL: zasilacz w komplecie  
 cz: napájecí zdroj je součástí dodávky  
 sk: napájací zdroj je súčasťou dodávky

PL: W skład oprawy wchodzi wbudowane lampy LED  
 cz: Toto svítidlo obsahuje zabudované světelné zdroje LED  
 sk: Toto svietidlo obsahuje zabudované svetelné zdroje LED

PL: Nie można wymieniać lamp w oprawie  
 cz: Světelné zdroje v tomto svítidle nelze vyměnit  
 sk: Svetelné zdroje v svietidle sa nedajú vymeniť

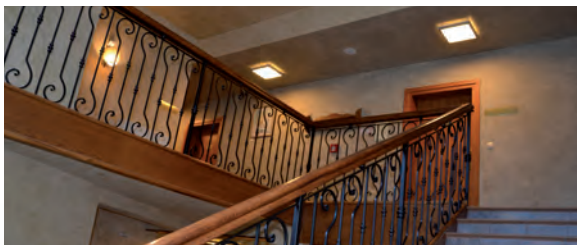

# LEON LED / SOLA LED

## Plafoniera SMD LED

cz: Plafon SMD LED / sk: Plafón SMD LED



1 LEON LED 12W 4000K



2 LEON LED 16W 4000K



3 LEON LED 24W 4000K



4 SOLA LED 12W 4000K



5 SOLA LED 16W 4000K



6 SOLA LED 24W 4000K

220-240V-	SMD LED		
4000K	160°	>80	30000h
44		0,5	

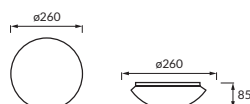

1 LEON LED 12W 4000K

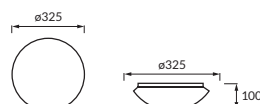

2 LEON LED 16W 4000K

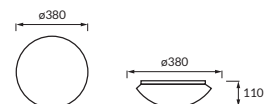

3 LEON LED 24W 4000K

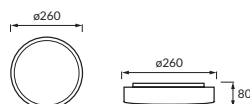

4 SOLA LED 12W 4000K

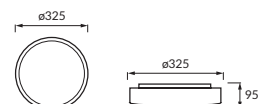

5 SOLA LED 16W 4000K

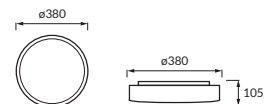

6 SOLA LED 24W 4000K

**Materiál / Materiál / Materiál**  
 PL: blacha stalowa, tworzywo sztuczne  
 cz: kovový výlisek, plast  
 sk: kovový výlisek, plast

**Uwagi / Komentář / Komentáře**  
 PL: zasilacz w komplecie  
 cz: napájecí zdroj je součástí dodávky  
 sk: napájací zdroj je súčasťou dodávky

1	01234	ABCDE	02780	LEON LED 12W 4000K	12 W	960 lm	5901477327803
2			02781	LEON LED 16W 4000K	16 W	1280 lm	5901477327810
3			02782	LEON LED 24W 4000K	24 W	1980 lm	5901477327827
4			02783	SOLA LED 12W 4000K	12 W	960 lm	5901477327834
5			02784	SOLA LED 16W 4000K	16 W	1280 lm	5901477327841
6			02785	SOLA LED 24W 4000K	24 W	1980 lm	5901477327858

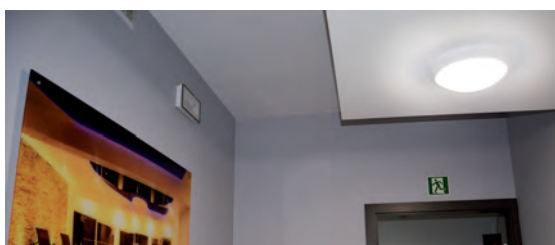

PL: W skład oprawy wchodzi wbudowane lampy LED  
 cz: Toto svítidlo obsahuje zabudované světelné zdroje LED  
 sk: Toto svietidlo obsahuje zabudované svetelné zdroje LED

PL: Nie można wymieniać lamp w sprawie  
 cz: Světelné zdroje v tomto svítidle nelze vyměnit  
 sk: Svetelné zdroje v svietidle sa nedajú vymeniť



1 LEON LED S 12W 4000K



2 LEON LED S 16W 4000K



3 SOLA LED S 12W 4000K



4 SOLA LED S 16W 4000K

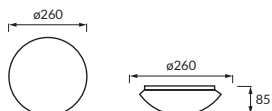

1 LEON LED S 12W 4000K

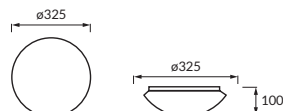

2 LEON LED S 16W 4000K

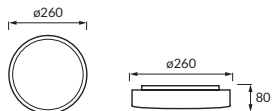

3 SOLA LED S 12W 4000K

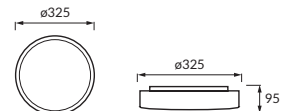

4 SOLA LED S 16W 4000K

220-240V~	SMD LED		
4000K	MICRO	160°	>80
30000h	IP 44		0,5

	01234	ABCDE					
1	03063	LEON LED S 12W 4000K	12 W	960 lm	biały biła biely	neutralna biała neutrálňí biła neutrálna biela	5901477330636
2	03064	LEON LED S 16W 4000K	16 W	1280 lm			5901477330643
3	03065	SOLA LED S 12W 4000K	12 W	960 lm	biały biła biely	neutralna biała neutrálňí biła neutrálna biela	5901477330650
4	03066	SOLA LED S 16W 4000K	16 W	1280 lm			5901477330667

**Materiał / Materiál / Material**

PL: blacha stalowa, tworzywo sztuczne  
 cz: kovový výlisek, plast  
 sk: kovový výlisok, plast

**Uwagi / Komentář / Komentáre**

PL: zasilacz w komplecie  
 cz: napájecí zdroj je součástí dodávky  
 sk: napájací zdroj je súčasťou dodávky

PL: W skład oprawy wchodzi wbudowane lampy LED  
 cz: Toto světlo obsahuje zabudované světelné zdroje LED  
 sk: Toto svetlo obsahuje zabudované svetelné zdroje LED

PL: Nie można wymieniać lamp w sprawie  
 cz: Světelné zdroje v tomto světidle nelze vyměnit  
 sk: Svetelné zdroje v svetidle sa nedajú vymeniť

**Uwagi / Komentář / Komentáre**  
 PL: załączenie przy świetle < 30 lux  
 cz: působí na okolní světlo pod 30lx  
 sk: pôsobí na okolité svetlo pod 30lx

**Uwagi / Komentář / Komentáre**  
 PL: zasięg wykrywania ruchu max 6m (<24°C)  
 cz: maximální dosah čidla 6m (<24°C)  
 sk: maximálny dosah čidla 6m (<24°C)

**Uwagi / Komentář / Komentáre**  
 PL: wyłączenie po 20s bez ruchu  
 cz: doba svícení 20s  
 sk: doba svietenia 20s

**Uwagi / Komentář / Komentáre**  
 PL: kąt działania czujnika 360°  
 cz: rozsah čidla pohybu 360°  
 sk: uhol činnosti pohybového čidla 360°



# TINA SENSORLU LED 360 / SENSORLU 360 KARO

ideus

Plafoniera z czujnikiem ruchu

*cz:* Svítidlo přisazené s pohybovým čidlem / *sk:* Svetidlo prisadené s pohybovým čidlom



1 TINA SENSORLU LED 360 WHITE



2 SENSORLU 360 KARO

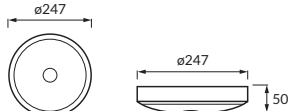
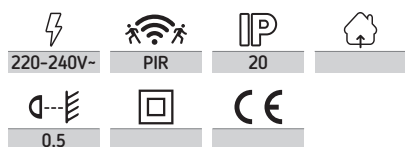

1 TINA SENSORLU LED 360 WHITE

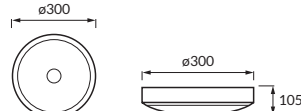

2 SENSORLU 360 KARO

1	02807	TINA SENSORLU LED 360 WHITE	15 W	1190 lm	-	SMD LED	×	×	biały biłá biely	neutralna biła neutrální biłá neutrálna biela	4000K	120°	>80	30000h	5901477328077
2	02545	SENSORLU 360 KARO	2 x max 25 W	-	E27		✓	✓		-	-	-	-	-	5901477325458

## 1 TINA SENSORLU LED 360 WHITE

### Materiał / Materiál / Materiál

*PL:* tworzywo sztuczne, poliwęglan PC  
*CZ:* plast, polykarbonát PC  
*SK:* plast, polykarbonát PC

## 2 SENSORLU 360 KARO

### Materiał / Materiál / Materiál

*PL:* blacha stalowa, szkło  
*CZ:* kovový výlisok, sklo  
*SK:* kovový výlisok, sklo

## 1 TINA SENSORLU LED 360 WHITE

### Uwagi / Komentarz / Kommentáre

*PL:* regulacja czasu świecenia od 10s do 3min  
*CZ:* možnost regulace doby svícení od 10s do 3min  
*SK:* možnosť regulácie doby svietenia od 10s do 3min

## 2 SENSORLU 360 KARO

### Uwagi / Komentarz / Kommentáre

*PL:* regulacja czasu świecenia od 10s do 5min  
*CZ:* možnost regulace doby svícení od 10s do 5min  
*SK:* možnosť regulácie doby svietenia od 10s do 5min

### Uwagi / Komentarz / Kommentáre

*PL:* kąt działania czujnika 360°  
*CZ:* rozsah čidla pohybu 360°  
*SK:* uhol činnosti pohybového čidla 360°

### Uwagi / Komentarz / Kommentáre

*PL:* zasięg wykrywania ruchu max 8m (<24°C)  
*CZ:* maximální dosah čidla 8m (<24°C)  
*SK:* maximálny dosah čidla 8m (<24°C)

### Uwagi / Komentarz / Kommentáre

*PL:* możliwość ustawienia poziomu natężenia oświetlenia otoczenia (3-2000lx), przy którym urządzenie pracuje  
*CZ:* možnost nastavení úrovně osvětlení (3-2000lx), při němž zařízení pracuje  
*SK:* možnosť nastavenia úrovne osvetlenia (3-2000lx), pri ktorom zariadenie pracuje

## 1 TINA SENSORLU LED 360 WHITE

*PL:* W skład oprawy wchodzi wbudowane lampy LED  
*CZ:* Toto svítidlo obsahuje zabudované světelné zdroje LED  
*SK:* Toto svetidlo obsahuje zabudované svetelné zdroje LED



*PL:* Nie można wymieniać lamp w oprawie  
*CZ:* Světelné zdroje v tomto svítidle nelze vyměnit  
*SK:* Svetelné zdroje v svetidle sa nedajú vymeniť

## 2 SENSORLU 360 KARO

*PL:* Oprawa jest przystosowana do żarówek o klasach energetycznych:  
*CZ:* Toto svítidlo je kompatibilní s žárovkami energetické třídy:  
*SK:* Toto svetidlo je kompatibilné so žiarovkami energetických tried:

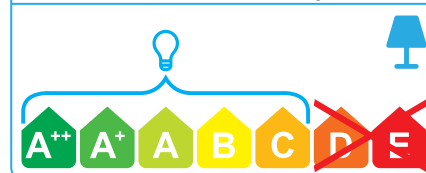



① ATMA ACL-343



② ATMA ACL-344

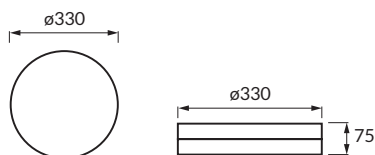

① ② ATMA ACL

220-240V~	2 x max 36W	E27	
IP 20		0,5	

**Materiál / Materiál / Material**

PL: stal nierdzewna, poliwęglan PC  
 cz: nerezová ocel, polykarbonát PC  
 sk: nerezová ocel, polykarbonát PC

	01234			
1	00343	ATMA ACL-343	chrom / chrom / chróm	5901477303432
2	00344	ATMA ACL-344	matowy chrom / matný chrom / matný chróm	5901477303449



PL: Oprawa jest przystosowana do żarówek o klasach energetycznych:  
 cz: Toto svítidlo je kompatibilní s žárovkami energetické třídy:  
 sk: Toto svietidlo je kompatibilné so žiarovkami energetických tried:

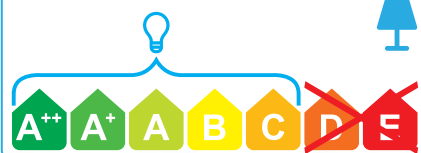

# ILGAZ HL634 / KONAK HL635

ideus

Plafoniera

cz: Plafon / sk: Plafón



1 ILGAZ-1 HL634S  
CHROME+MATCHR



2 ILGAZ-2 HL634M  
CHROME+MATCHR



3 ILGAZ-3 HL634B  
CHROME+MATCHR



4 KONAK-1 HL635S  
CHROME+MATCHR



5 KONAK-2 HL635M  
CHROME+MATCHR



6 KONAK-3 HL635B  
CHROME+MATCHR

220-240V~	E27		20
	0,5		

**Materiał / Materiál / Material**

PL: stal, szkło  
CZ: ocel, sklo  
SK: ocel, sklo

1 ILGAZ-1 HL634S CHROME+MATCHR	2 ILGAZ-2 HL634M CHROME+MATCHR	3 ILGAZ-3 HL634B CHROME+MATCHR
4 KONAK-1 HL635S CHROME+MATCHR	5 KONAK-2 HL635M CHROME+MATCHR	6 KONAK-3 HL635B CHROME+MATCHR

1	00617	ILGAZ-1 HL634S CHROME+MATCHR	max 60 W	5901477306174
2	00618	ILGAZ-2 HL634M CHROME+MATCHR	max 60 W	5901477306181
3	00620	ILGAZ-3 HL634B CHROME+MATCHR	2 x max 60 W	5901477306204
4	00621	KONAK-1 HL635S CHROME+MATCHR	max 60 W	5901477306211
5	00622	KONAK-2 HL635M CHROME+MATCHR	max 60 W	5901477306228
6	00624	KONAK-3 HL635B CHROME+MATCHR	2 x max 60 W	5901477306242

PL: Oprawa jest przystosowana do żarówek o klasach energetycznych:  
CZ: Toto svítidlo je kompatibilní s žárovkami energetické třídy:  
SK: Toto svietidlo je kompatibilné so žiarovkami energetických tried:

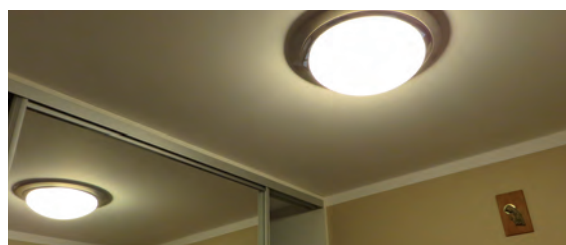
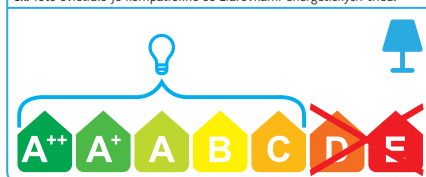





1 UFO WIND ROSE



2 UFO NAZAR



3 UFO ZAGREP



4 UFO ERCCIYES



5 UFO STAR

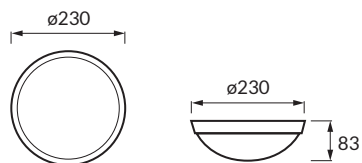

1 ... 5 UFO

220-240V~	max 40W	E27	
IP 20		0,5	

	01234	ABCDE		
1	01981	UFO WIND ROSE		5901477319815
2	01982	UFO NAZAR	biały biłá biely	5901477319822
3	01983	UFO ZAGREP		5901477319839
4	01984	UFO ERCCIYES		5901477319846
5	02223	UFO STAR		5901477322235

<b>Materiał / Materiál / Material</b>
PL: tworzywo sztuczne
CZ: plast
SK: plast



PL: Oprawa jest przystosowana do żarówek o klasach energetycznych:  
 CZ: Toto svetidlo je kompatibilní s žárovkami energetické třídy:  
 SK: Toto svetidlo je kompatibilné so žiarovkami energetických tried:

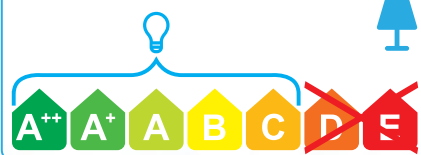



1 GLOP WIND ROSE



2 GLOP FAVORI

220-240V-	max 60W	E27	
IP 20		0,5	

**Materiał / Materiál / Material**

PL: tworzywo sztuczne

CZ: plast

SK: plast

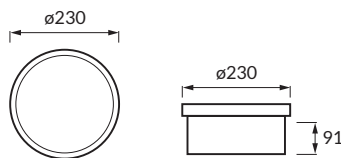

1 2 GLOP

	01234	ABCDE		
1	01985	GLOP WIND ROSE	biały	5901477319853
2	01986	GLOP FAVORI	bielá biely	5901477319860



PL: Oprawa jest przystosowana do żarówek o klasach energetycznych:

CZ: Toto svítidlo je kompatibilní s žárovkami energetické třídy:

SK: Toto svetidlo je kompatibilné so žiarovkami energetických tried:

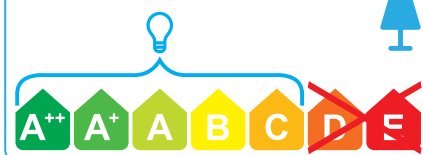



1 LOLLY WHITE

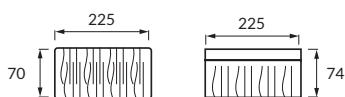

1 LOLLY WHITE

220-240V-	max 15W	E27	
IP 20		0,5	

Materiał / Materiál / Materiál

PL: tworzywo sztuczne

cz: plast

sk: plast

	01234	ABCDE		
1	02369	LOLLY WHITE	biały / biłá / biely	5901477323690



PL: Oprawa jest przystosowana do żarówek o klasach energetycznych:

cz: Toto svítidlo je kompatibilní s žárovkami energetické třídy:

sk: Toto svietidlo je kompatibilné so žiarovkami energetických tried:

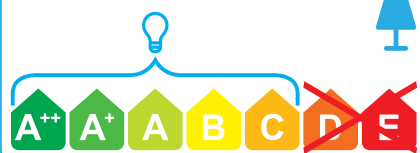



# FLUE / NINOVA



Plafoniera

cz: Plafon / sk: Plafón



1 FLUE WALL FIXTURE WHITE



2 FLUE WALL FIXTURE WALNUT



3 FLUE WALL FIXTURE MAPLE



4 NINOVA WALL FIXTURE WHITE



5 NINOVA WALL FIXTURE WALNUT



6 NINOVA WALL FIXTURE MAPLE

220-240V-	max 26W	E27	
IP 20		0,5	

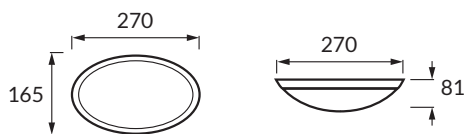

1...6 FLUE / NINOVA

**Materiál / Material / Material**  
 PL: tworzywo sztuczne  
 cz: plast  
 sk: plast

	01234	ABCDE		
1	02023	FLUE WALL FIXTURE WHITE	biały / bilá / biely	5901477320231
2	02026	FLUE WALL FIXTURE WALNUT	mahoń / mahagon / mahagón	5901477320262
3	02027	FLUE WALL FIXTURE MAPLE	sosna / borovice / borovica	5901477320279
4	02028	NINOVA WALL FIXTURE WHITE	biały / bilá / biely	5901477320286
5	02031	NINOVA WALL FIXTURE WALNUT	mahoń / mahagon / mahagón	5901477320316
6	02032	NINOVA WALL FIXTURE MAPLE	sosna / borovice / borovica	5901477320323



PL: Oprawa jest przystosowana do żarówek o klasach energetycznych:  
 cz: Toto svietidlo je kompatibilní s žárovkami energetické třídy:  
 sk: Toto svetidlo je kompatibilné so žiarovkami energetických tried:

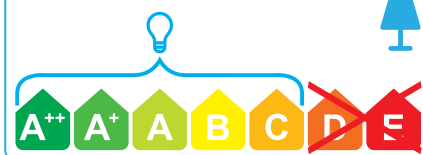



1 SQUARE CLASSIC WHITE



2 SQUARE CLASSIC SILVER



3 SQUARE CLASSIC WALNUT



4 SQUARE CLASSIC MAPLE



5 SQUARE MODERN WHITE



6 SQUARE MODERN SILVER



7 SQUARE MODERN WALNUT



8 SQUARE MODERN MAPLE

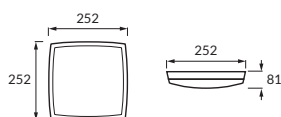

1 2 3 SQUARE

220-240V~	max 26W	E27	
IP 20		0,5	

CE

	01234	ABCDE		
1	01987	SQUARE CLASSIC WHITE	biały / bílá / biely	5901477319877
2	01988	SQUARE CLASSIC SILVER	srebrny / stříbrná / strieborná	5901477319884
3	01990	SQUARE CLASSIC WALNUT	mahoń / mahagon / mahagón	5901477319907
4	01991	SQUARE CLASSIC MAPLE	sosna / borovice / borovica	5901477319914
5	01992	SQUARE MODERN WHITE	biały / bílá / biely	5901477319921
6	01993	SQUARE MODERN SILVER	srebrny / stříbrná / strieborná	5901477319938
7	01995	SQUARE MODERN WALNUT	mahoń / mahagon / mahagón	5901477319952
8	01996	SQUARE MODERN MAPLE	sosna / borovice / borovica	5901477319969

**Materiał / Materiál / Material**

PL: tworzywo sztuczne

CZ: plast

SK: plast

PL: Oprawa jest przystosowana do żarówek o klasach energetycznych:

CZ: Toto svítidlo je kompatibilní s žárovkami energetické třídy:

SK: Toto svetidlo je kompatibilné so žiarovkami energetických tried:

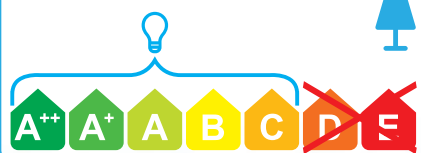

# BIG UFO



## Plafoniera

cz: Plafon / sk: Plafón



1 BIG UFO BULUT WHITE



2 BIG UFO BULUT SILVER



3 BIG UFO BULUT GOLDEN



4 BIG UFO BULUT WALNUT



5 BIG UFO ZAGREP WHITE



6 BIG UFO ZAGREP GOLDEN



7 BIG UFO ZAGREP MAPLE

220-240V- 2 x max 26W E27   
 IP20 0,5   
 CE

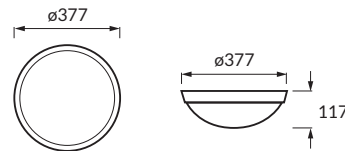

1...7 BIG UFO

**Material / Materiál / Materiál**  
 PL: tworzywo sztuczne  
 cz: plast  
 sk: plast

	01234	ABCDE		
1	02007	BIG UFO BULUT WHITE	biały / biłá / biely	5901477320071
2	02008	BIG UFO BULUT SILVER	srebrny / stříbrná / strieborná	5901477320088
3	02009	BIG UFO BULUT GOLDEN	złoty / zlatá / zlatá	5901477320095
4	02010	BIG UFO BULUT WALNUT	mahoń / mahagon / mahagón	5901477320101
5	02012	BIG UFO ZAGREP WHITE	biały / biłá / biely	5901477320125
6	02014	BIG UFO ZAGREP GOLDEN	złoty / zlatá / zlatá	5901477320149
7	02016	BIG UFO ZAGREP MAPLE	sosna / borovice / borovica	5901477320163



PL: Oprawa jest przystosowana do żarówek o klasach energetycznych:  
 cz: Toto svítidlo je kompatibilní s žárovkami energetické třídy:  
 sk: Toto svietidlo je kompatibilné so žiarovkami energetických tried:

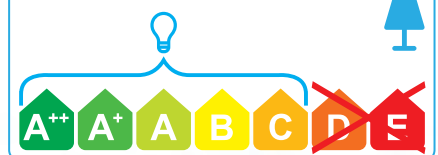





1 BIG SQUARE CLASSIC WHITE



2 BIG SQUARE CLASSIC SILVER



3 BIG SQUARE CLASSIC WALNUT



4 BIG SQUARE CLASSIC MAPLE



5 BIG SQUARE MODERN WHITE



6 BIG SQUARE MODERN WALNUT



7 BIG SQUARE MODERN MAPLE

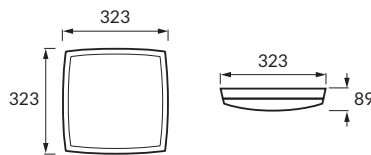

1 ... 7 BIG SQUARE

220-240V-	2 x max 26W	E27	
IP 20		0,5	

	01234	ABCDE		
1	01997	BIG SQUARE CLASSIC WHITE	biały / bílá / biely	5901477319976
2	01998	BIG SQUARE CLASSIC SILVER	srebrny / stříbrná / strieborná	5901477319983
3	02000	BIG SQUARE CLASSIC WALNUT	mahoń / mahagon / mahagón	5901477320002
4	02001	BIG SQUARE CLASSIC MAPLE	sosna / borovice / borovica	5901477320019
5	02002	BIG SQUARE MODERN WHITE	biały / bílá / biely	5901477320026
6	02005	BIG SQUARE MODERN WALNUT	mahoń / mahagon / mahagón	5901477320057
7	02006	BIG SQUARE MODERN MAPLE	sosna / borovice / borovica	5901477320064

Materiał / Material / Material
PL: tworzywo sztuczne
CZ: plast
SK: plast

PL: Oprawa jest przystosowana do żarówek o klasach energetycznych:  
 cz: Toto svietidlo je kompatibilni s žárovkami energetické třídy:  
 sk: Toto svietidlo je kompatibilné so žiarovkami energetických tried:

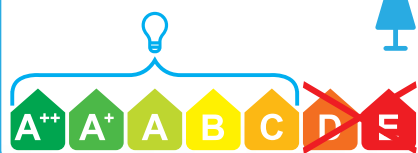

# FLAMINGO / BRENA / PELIKAN

## Oprawa dekoracyjna SMD LED

**CZ:** Dekorační SMD LED svítidlo / **SK:** Dekoračné SMD LED svetidlo



1 FLAMINGO-4 HL6641L CHROME 4200K



2 BRENA LED 4W MAT CHROME 4000K



3 BRENA LED 4W ANTIC BRASS 4000K



4 FLAMINGO-6 HL6642L CHROME 4200K



5 BRENA LED 6W MAT CHROME 4000K



6 BRENA LED 6W ANTIC BRASS 4000K



7 PELIKAN HL6631L CHROME 4200K

220-240V-			4000K
60°	CRI >80	30000h	IP 20
	0,5		

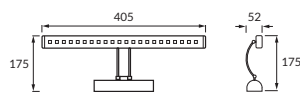

1 2 3 FLAMINGO-4, BRENA LED 4W

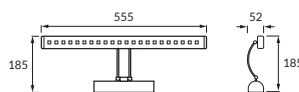

4 5 6 FLAMINGO-6, BRENA LED 6W

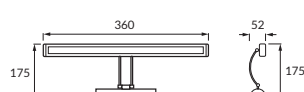

7 PELIKAN HL6631L

01234	ABCDE							
1 02479	FLAMINGO-4 HL6641L CHROME 4200K	4 W	21 SMD LED	354 lm	chrom / chrom / chróm	neutralna biela neutrální bílá neutrálna biela	ON OFF	5901477324796
2 03068	BRENA LED 4W MAT CHROME 4000K				matowy chrom / matný chrom / matný chróm			5901477330681
3 03069	BRENA LED 4W ANTIC BRASS 4000K				antyczny mosiądz / mosaz s patinou / mosadz s patinou			5901477330698
4 02480	FLAMINGO-6 HL6642L CHROME 4200K	6 W	30 SMD LED	500 lm	chrom / chrom / chróm			5901477324802
5 03070	BRENA LED 6W MAT CHROME 4000K				matowy chrom / matný chrom / matný chróm			5901477330704
6 03071	BRENA LED 6W ANTIC BRASS 4000K				antyczny mosiądz / mosaz s patinou / mosadz s patinou			5901477330711
7 02701	PELIKAN HL6631L CHROME 4200K	4 W	21 SMD LED	250 lm	chrom / chrom / chróm			×

### Materiał / Materiál / Material

PL: stal nierdzewna  
CZ: nerezová ocel  
SK: nerezová ocel

### Uwagi / Komentář / Komentáre

PL: zasilacz w komplecie  
CZ: napájecí zdroj je součástí dodávky  
SK: napájací zdroj je súčasťou dodávky



PL: W skład oprawy wchodzi wbudowane lampy LED  
CZ: Toto svítidlo obsahuje zabudované světelné zdroje LED  
SK: Toto svetidlo obsahuje zabudované svetelné zdroje LED



PL: Nie można wymieniać lamp w oprawie  
CZ: Světelné zdroje v tomto svítidle nelze vyměnit  
SK: Svetelné zdroje v svetidle sa nedajú vymeniť



1 ALBATROS-4 HL6651L CHROME 4200K



2 RITON LED 4W MAT CHROME 4000K



3 RITON LED 4W ANTIC BRASS 4000K



4 ALBATROS-6 HL6652L CHROME 4200K



5 RITON LED 6W MAT CHROME 4000K



6 RITON LED 6W ANTIC BRASS 4000K

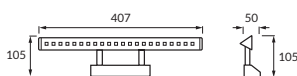

1 2 3 ALBATROS-4, RITON 4W

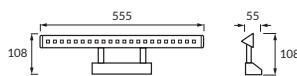

4 5 6 ALBATROS-6, RITON 6W

220-240V-	CRI >80	30000h	4000K
60°	>80	ON/OFF	
IP 20		0,5	

01234	ABCDE							
1	02481	ALBATROS-4 HL6651L CHROME 4200K	4W	21 SMD LED	354 lm	chrom / chrom / chróm	neutralna biela neutrální bílá neutrálna biela	5901477324819
2	03072	RITON LED 4W MAT CHROME 4000K				matowy chrom / matný chrom / matný chróm		5901477330728
3	03073	RITON LED 4W ANTIC BRASS 4000K				antyczny mosiądz / mosaz s patinou / mosadz s patinou		5901477330735
4	02482	ALBATROS-6 HL6652L CHROME 4200K	6W	30 SMD LED	500 lm	chrom / chrom / chróm		5901477324826
5	03074	RITON LED 6W MAT CHROME 4000K				matowy chrom / matný chrom / matný chróm		5901477330742
6	03075	RITON LED 6W ANTIC BRASS 4000K				antyczny mosiądz / mosaz s patinou / mosadz s patinou		5901477330759

**Materiał / Materiál / Material**  
 PL: stal nierdzewna  
 CZ: nerezová ocel  
 SK: nerezová ocel

**Uwagi / Komentář / Komentáre**  
 PL: zasilacz w komplecie  
 CZ: napájecí zdroj je součástí dodávky  
 SK: napájací zdroj je súčasťou dodávky



PL: W skład oprawy wchodzi wbudowane lampy LED  
 CZ: Toto svítidlo obsahuje zabudované světelné zdroje LED  
 SK: Toto svetidlo obsahuje zabudované svetelné zdroje LED

**LED**

PL: Nie można wymieniać lamp w oprawie  
 CZ: Světelné zdroje v tomto svítidle nelze vyměnit  
 SK: Svetelné zdroje v svetidle sa nedajú vymeniť



# NADIA G9

## Oprawa dekoracyjjna

*cz:* Dekorační svítidlo / *sk:* Dekoračné svetidlo



1 NADIA G9 CHROME

2 NADIA G9 MAT CHROME

220-240V-	2 x max 40W	G9	G9
	IP 20		0,5

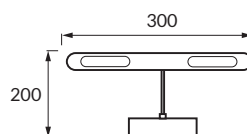

1 2 NADIA G9

Materiał / Materiál / Material
PL: stal nierdzewna
CZ: nerezová ocel
SK: nerezová ocel

	01234	ABCDE		
1	01674	NADIA G9 CHROME	chrom / chrom / chróm	5901477316746
2	01675	NADIA G9 MAT CHROME	matowy chrom / matný chrom / matný chróm	5901477316753



PL: Oprawa jest przystosowana do żarówek o klasach energetycznych:  
 CZ: Toto svítidlo je kompatibilní s žárovkami energetické třídy:  
 SK: Toto svetidlo je kompatibilné so žiarovkami energetických tried:



PL: Oprawa sprzedaje się z żarówkami o klasie energetycznej C  
 CZ: Toto svítidlo se prodává s žárovkami energetické třídy C  
 SK: Toto svetidlo sa predáva so žiarovkami energetickéj triedy C



1 AMELIA LED CHROME 4000K

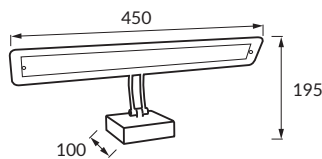

1 AMELIA LED CHROME 4000K

220-240V~	8,5W	SMD LED	765lm
		4000K	60°
>80	30000h		
44	0,5		

	01234	ABCDE			
1	03056	AMELIA LED CHROME 4000K	chrom chrom chróm	neutralna biata neutrální bílá neutrálna biela	5901477330568

**Materiał / Materiál / Material**

PL: aluminium, szkło

cz: hliník, sklo

sk: hliník, sklo

**Uwagi / Komentář / Komentáre**

PL: zasilacz w komplecie

cz: napájecí zdroj je součástí dodávky

sk: napájací zdroj je súčasťou dodávky



PL: W skład oprawy wchodzi wbudowane lampy LED  
 cz: Toto svítidlo obsahuje zabudované světelné zdroje LED  
 sk: Toto svietidlo obsahuje zabudované svetelné zdroje LED



PL: Nie można wymieniać lamp w oprawie  
 cz: Světelné zdroje v tomto svítidle nelze vyměnit  
 sk: Svetelné zdroje v svietidle sa nedajú vymeniť

# GABI LED / ZUZA LED

ideus

Oprawa ścienna-sufitowa SMD LED

cz: Svítidlo přisazené SMD LED / sk: Nástenné-stropné SMD LED svietidlo

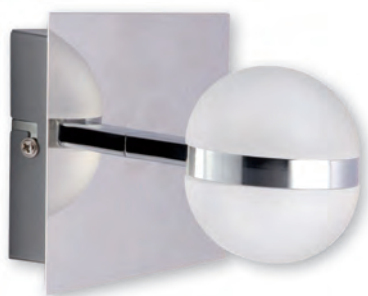

1 GABI LED 1D 3000K



2 GABI LED 2L 3000K



3 ZUZA LED 1L 3000K



4 ZUZA LED 2L 3000K

220-240V~	SMD LED		
3000K	120°	>80	30000h
	44	0,5	

CE

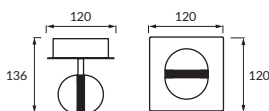

1 GABI LED 1D 3000K



2 GABI LED 2L 3000K

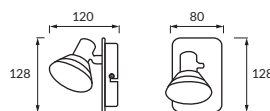

3 ZUZA LED 1L 3000K

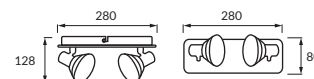

4 ZUZA LED 2L 3000K

**Materiał / Materiál / Material**

PL: stal nierdzewna, szkło  
 CZ: nerezová ocel, sklo  
 SK: nerezová ocel, sklo

**Uwagi / Komentář / Komentáre**

PL: zasilacz w komplecie  
 CZ: napájecí zdroj je součástí dodávky  
 SK: napájací zdroj je súčasťou dodávky

	01234	ABCDE						
1	02846	GABI LED 1D 3000K	2 x 3 W	2 x 245 lm	chrom chrom chróm	ciepłobiała teplá biela teplá biela	×	5901477328466
2	02847	GABI LED 2L 3000K	4 x 3 W	4 x 245 lm			×	5901477328473
3	02844	ZUZA LED 1L 3000K	6 W	490 lm	chrom chrom chróm	ciepłobiała teplá biela teplá biela	✓	5901477328442
4	02845	ZUZA LED 2L 3000K	2 x 6 W	2 x 490 lm			✓	5901477328459

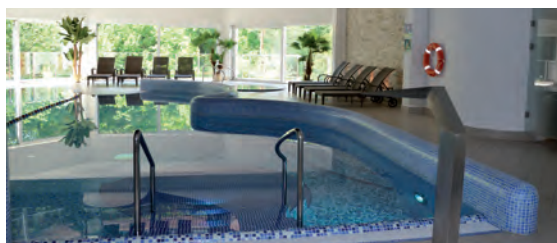

PL: W skład oprawy wchodzi wbudowane lampy LED  
 CZ: Toto svítidlo obsahuje zabudované světelné zdroje LED  
 SK: Toto svietidlo obsahuje zabudované svetelné zdroje LED

**LED**

LED LED A++ A+ A B C D E

PL: Nie można wymieniać lamp w oprawie  
 CZ: Světelné zdroje v tomto svítidle nelze vyměnit  
 SK: Svetelné zdroje v svietidle sa nedajú vymeniť





1 BETI LED C 5W 4000K



2 BETI LED C 10W 4000K



3 BETI LED L 5W 4000K



4 BETI LED L 10W 4000K

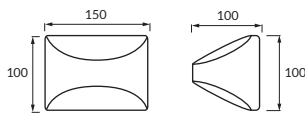

1 BETI LED C 5W 4000K

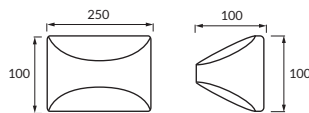

2 BETI LED C 10W 4000K

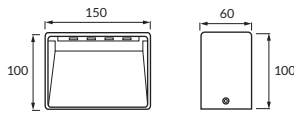

3 BETI LED L 5W 4000K

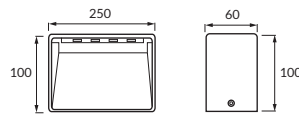

4 BETI LED L 10W 4000K

220-240V-	SMD LED		
Tc(N) SOLMS	140°	CRI [Ra]	30000h
IP 20		0,5	

**Materiał / Materiál / Material**

PL: odlew stopu aluminium

CZ: odlitek z hliníkové slitiny

SK: odliatok z hliníkovej zliatiny

**Uwagi / Komentář / Komentáre**

PL: zasilacz w komplecie

CZ: napájecí zdroj je součástí dodávky

SK: napájací zdroj je súčasťou dodávky

Image	Code	Model	Power	Light Output	Color	Material	Barcode
	01234	BETI LED C 5W 4000K	5 W	400 lm	biely	neutralna biela	5901477331008
	03100	BETI LED C 5W 4000K	5 W	400 lm	biely	neutralna biela	5901477331015
	03101	BETI LED C 10W 4000K	10 W	820 lm	biely	neutralna biela	5901477331022
	03102	BETI LED L 5W 4000K	5 W	400 lm	biely	neutralna biela	5901477331039
	03103	BETI LED L 10W 4000K	10 W	820 lm	biely	neutralna biela	5901477331039

PL: W skład oprawy wchodzi wbudowane lampy LED  
 CZ: Toto svítidlo obsahuje zabudované svetelné zdroje LED  
 SK: Toto svietidlo obsahuje zabudované svetelné zdroje LED



PL: Nie można wymieniać lamp w oprawie  
 CZ: Světelné zdroje v tomto svítidle nelze vyměnit  
 SK: Svetelné zdroje v svietidle sa nedajú vymeniť

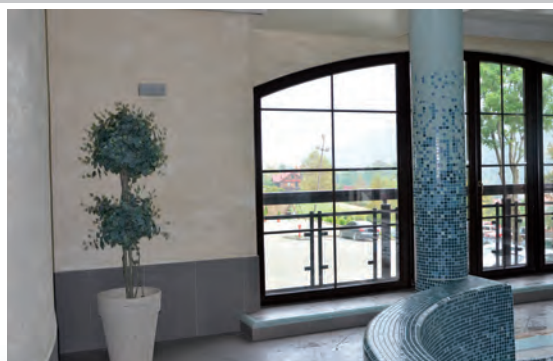

# ERDEK HL855L / AVANOS HL857L

Oprawa dekoracyjna SMD LED

cz: Dekorační SMD LED svítidlo / sk: Dekoračné SMD LED svetidlo



1 ERDEK HL855L WHITE 4000K



2 AVANOS HL857L CHROME 4200K

220-240V-	SMD LED	180°	CRI >80
4000K	IP 20		30000h

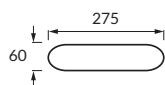

1 ERDEK HL855L WHITE 4000K

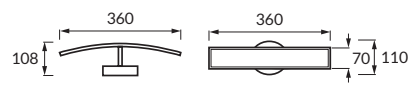

2 AVANOS HL857L CHROME 4200K

	01234	ABCDE					
1	02638	ERDEK HL855L WHITE 4000K	5 W	325 lm	biały / bílá / biely	neutralna biała neutrální bílá	5901477326387
2	02639	AVANOS HL857L CHROME 4200K	8 W	390 lm	chrom / chrom / chróm	neutralna biała	5901477326394

1 ERDEK HL855L WHITE 4000K

**Materiał / Materiál / Material**

PL: blacha stalowa, szkło  
CZ: kovový výlisek, sklo  
SK: kovový výlisek, sklo

2 AVANOS HL857L CHROME 4200K

**Materiał / Materiál / Material**

PL: blacha stalowa, tworzywo sztuczne  
CZ: kovový výlisek, plast  
SK: kovový výlisek, plast

**Uwagi / Komentář / Komentáře**

PL: zasilacz w komplecie  
CZ: napájecí zdroj je součástí dodávky  
SK: napájecí zdroj je súčasťou dodávky



PL: W skład oprawy wchodzi wbudowane lampy LED  
CZ: Toto svítidlo obsahuje zabudované světelné zdroje LED  
SK: Toto svetidlo obsahuje zabudované svetelné zdroje LED

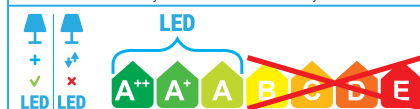

PL: Nie można wymieniać lamp w oprawie  
CZ: Světelné zdroje v tomto svítidle nelze vyměnit  
SK: Svetelné zdroje v svetidle sa nedajú vymeniť



1 KUGU LORI LED 1V 3W



2 TURNA LORI LED 1U 3W



3 FLORYA-3 LED CHROME



4 FLORYA-6 LED CHROME

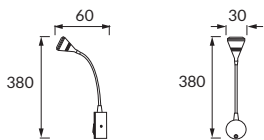

1 KUGU LORI LED 1V 3W

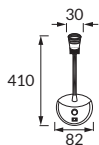

3 FLORYA-3 LED CHROME

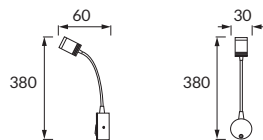

2 TURNA LORI LED 1U 3W

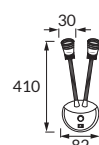

4 FLORYA-6 LED CHROME

220-240V-			4000K
30°	CRI >80 [Ra]	30000h	
	IP 20		0,5

1	01234	ABCDE							
1	02791	KUGU LORI LED 1V 3W		3 W	200 lm	srebrny / stříbrná / strieborná	neutralna biela neutrální bílá neutrálna biela		5901477327919
2	02792	TURNA LORI LED 1U 3W	POWER LED		170 lm				5901477327926
3	02936	FLORYA-3 LED CHROME		2 x 3 W	2 x 192 lm	chrom / chrom / chróm		5901477329364	
4	02937	FLORYA-6 LED CHROME	COB LED					5901477329371	



- 1 2 KUGU / TURNA
- Materiál / Materiál / Materiál**
- PL: odlew stopu aluminium  
 CZ: odlitek z hliníkové slitiny  
 SK: odliatok z hliníkovej zliatiny
- 3 4 FLORYA
- Materiál / Materiál / Materiál**
- PL: odlew stopu aluminium, blacha stalowa  
 CZ: odlitek z hliníkové slitiny, kovový výlisek  
 SK: odliatok z hliníkovej zliatiny, kovový výlisek
- Uwagi / Komentář / Komentáre**
- PL: zasílacz w komplecie  
 CZ: napájecí zdroj je součástí dodávky  
 SK: napájecí zdroj je súčasťou dodávky

PL: W skład oprawy wchodzi wbudowane lampy LED  
 CZ: Toto svítidlo obsahuje zabudované světelné zdroje LED  
 SK: Toto svetidlo obsahuje zabudované svetelné zdroje LED

PL: Nie można wymieniać lamp w oprawie  
 CZ: Světelné zdroje v tomto svítidle nelze vyměnit  
 SK: Svetelné zdroje v svetidle sa nedajú vymeniť



# KENT LED

## Oprawa ścienna-sufitowa SMD LED

cz: Svítidlo přisazené SMD LED / sk: Nástenné-stropné SMD LED svietidlo



① KENT LED 1D 3000K



② KENT LED 2L 3000K



③ KENT LED 3L 3000K



④ KENT LED 4D 3000K

220-240V-	SMD LED		
3000K	120°	CRI [Ra] >80	30000h
IP 20		0,5	

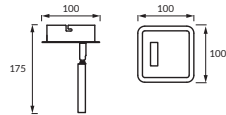

① KENT LED 1D 3000K

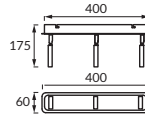

③ KENT LED 3L 3000K

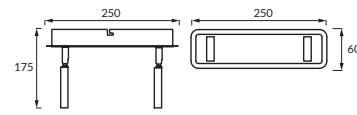

② KENT LED 2L 3000K

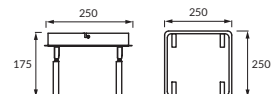

④ KENT LED 4D 3000K

<b>Materiał / Materiál / Material</b>
PL: stal nierdzewna, tworzywo sztuczne
CZ: nerezová ocel, plast
SK: nerezová ocel, plast

<b>Uwagi / Komentář / Komentáre</b>
PL: zasilacz w komplecie
CZ: napájecí zdroj je součástí dodávky
SK: napájací zdroj je súčasťou dodávky

	01234	ABCDE					
1	02769	KENT LED 1D 3000K	6 W	490 lm	chrom+wenge chrom+wenge chróm+wenge	ciepłobiała teplá bilá teplá biela	5901477327698
2	02770	KENT LED 2L 3000K	2 x 6 W	2 x 490 lm			5901477327704
3	02771	KENT LED 3L 3000K	3 x 6 W	3 x 490 lm			5901477327711
4	02772	KENT LED 4D 3000K	4 x 6 W	4 x 490 lm			5901477327728



PL: W skład oprawy wchodzi wbudowane lampy LED  
 CZ: Toto svítidlo obsahuje zabudované světelné zdroje LED  
 SK: Toto svietidlo obsahuje zabudované svetelné zdroje LED

PL: Nie można wymieniać lamp w oprawie  
 CZ: Světelné zdroje v tomto svítidle nelze vyměnit  
 SK: Svetelné zdroje v svietidle sa nedajú vymeniť

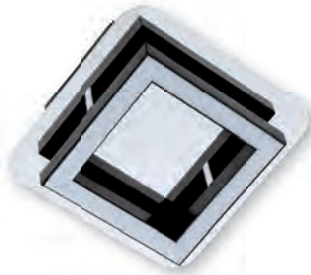

1 LIKYA LED-1 3000K



2 LIKYA LED-2 3000K

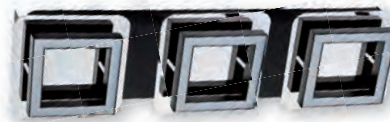

3 LIKYA LED-3 3000K

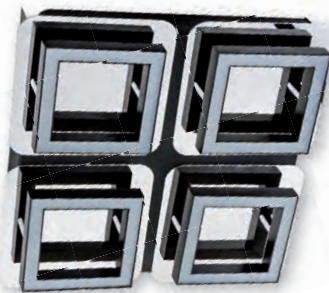

4 LIKYA LED-4 3000K



5 LIKYA LED-5 3000K

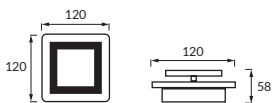

1 LIKYA LED-1 3000K



2 LIKYA LED-2 3000K

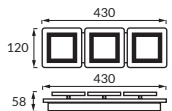

3 LIKYA LED-3 3000K

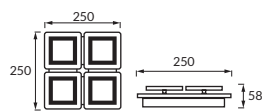

4 LIKYA LED-4 3000K

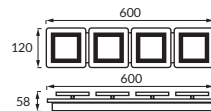

5 LIKYA LED-5 3000K

220-240V~	SMD LED		
3000K	120°	CRI >80	30000h
IP 20		0,5	

**Materiał / Materiál / Material**

PL: stal nierdzewna, tworzywo sztuczne  
 CZ: nerezová ocel, plast  
 SK: nerezová ocel, plast

**Uwagi / Komentář / Komentáre**

PL: zasílac w komplecie  
 CZ: napájecí zdroj je součástí dodávky  
 SK: napájací zdroj je súčasťou dodávky

Icon	01234	ABCDE	Icon	Icon	Icon	Icon	Icon
1	03134	LIKYA LED-1 3000K	5 W	150 lm			5901477331343
2	03135	LIKYA LED-2 3000K	2 x 5 W	2 x 150 lm	chrom+wenge	ciepłobiała	5901477331350
3	03136	LIKYA LED-3 3000K	3 x 5 W	3 x 150 lm	chrom+wenge	teplá bílá	5901477331367
4	03137	LIKYA LED-4 3000K	4 x 5 W	4 x 150 lm	chróm+wenge	teplá biela	5901477331374
5	03138	LIKYA LED-5 3000K	4 x 5 W	4 x 150 lm			5901477331381

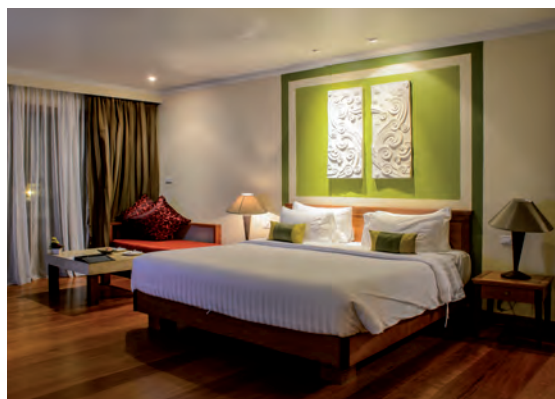

PL: W skład oprawy wchodzi wbudowane lampy LED  
 CZ: Toto svítidlo obsahuje zabudované světelné zdroje LED  
 SK: Toto svietidlo obsahuje zabudované svetelné zdroje LED

**LED**

LED LED A++ A+ A B C D E

PL: Nie można wymieniać lamp w oprawie  
 CZ: Světelné zdroje v tomto svítidle nelze vyměnit  
 SK: Svetelné zdroje v svietidle sa nedajú vymeniť

# DONAT LED

## Oprawa ścienna-sufitowa SMD LED

cz: Svítidlo přisazené SMD LED / sk: Nástenné-stropné SMD LED svietidlo



1 DONAT LED 1C 3000K



2 DONAT LED 2L 3000K



3 DONAT LED 3L 3000K



4 DONAT LED 4L 3000K

220-240V~	SMD LED		
Tc(K) S0C/M66 3000K	120°	CRI [Ra] >80	30000h
	20		0,5

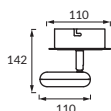

1 DONAT LED 1C 3000K

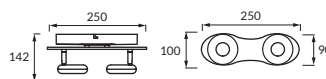

2 DONAT LED 2L 3000K

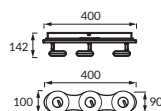

3 DONAT LED 3L 3000K

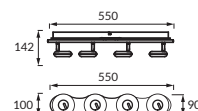

4 DONAT LED 4L 3000K

	<b>Materiał / Materiál / Material</b>
PL:	stal nierdzewna, tworzywo sztuczne
CZ:	nerezová ocel, plast
SK:	nerezová ocel, plast

	<b>Uwagi / Komentář / Komentáre</b>
PL:	zasilacz w komplecie
CZ:	napájecí zdroj je součástí dodávky
SK:	napájací zdroj je súčasťou dodávky

1	01234	ABCDE	6 W	490 lm			5901477327254
2	02725	DONAT LED 1C 3000K	2 x 6 W	2 x 490 lm	chrom	ciepłobiała	5901477327261
3	02726	DONAT LED 2L 3000K	3 x 6 W	3 x 490 lm	chrom	teplá bílá	5901477327278
4	02727	DONAT LED 3L 3000K	4 x 6 W	4 x 490 lm	chrom	teplá bílá	5901477327285



PL: W skład oprawy wchodzi wbudowane lampy LED  
 CZ: Toto svítidlo obsahuje zabudované světelné zdroje LED  
 SK: Toto svietidlo obsahuje zabudované svetelné zdroje LED

**LED**

PL: Nie można wymieniać lamp w oprawie  
 CZ: Světelné zdroje v tomto svítidle nelze vyměnit  
 SK: Svetelné zdroje v svietidle sa nedajú vymeniť





1 NELI LED 1L 3000K



2 NELI LED 2I 3000K



3 NELI LED 3I 3000K



5 NELI LED 3C 3000K



4 NELI LED 4I 3000K

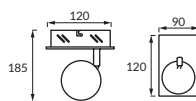

1 NELI LED 1L 3000K

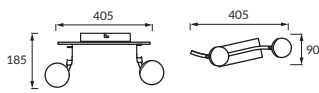

2 NELI LED 2I 3000K

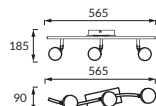

3 NELI LED 3I 3000K

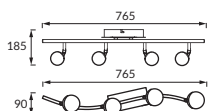

4 NELI LED 4I 3000K

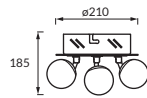

5 NELI LED 3C 3000K

220-240V~	SMD LED		
3000K	120°	CRI >80	30000h
IP 20			0,5

Image	Code	Model	Power	Lumen	Material	Color	Barcode
	02828	NELI LED 1L 3000K	6 W	490 lm			5901477328282
	02829	NELI LED 2I 3000K	2 x 6 W	2 x 490 lm	chrom	ciepłobiała	5901477328299
	02830	NELI LED 3I 3000K	3 x 6 W	3 x 490 lm	chrom	teplá bílá	5901477328305
	02831	NELI LED 4I 3000K	4 x 6 W	4 x 490 lm	chróm	teplá bíla	5901477328312
	02832	NELI LED 3C 3000K	3 x 6 W	3 x 490 lm			5901477328329

**Materiał / Materiál / Material**  
 PL: stal nierdzewna, szkło  
 CZ: nerezová ocel, sklo  
 SK: nerezová ocel, sklo

**Uwagi / Komentář / Komentáre**  
 PL: zasilacz w komplecie  
 CZ: napájecí zdroj je součástí dodávky  
 SK: napájací zdroj je súčasťou dodávky

PL: W skład oprawy wchodzi wbudowane lampy LED  
 CZ: Toto svítidlo obsahuje zabudované světelné zdroje LED  
 SK: Toto svietidlo obsahuje zabudované svetelné zdroje LED

**LED**

LED LED A++ A+ A B C D E

PL: Nie można wymieniać lamp w oprawie  
 CZ: Světelné zdroje v tomto svítidle nelze vyměnit  
 SK: Svetelné zdroje v svietidle sa nedajú vymeniť



# RUDA LED

ideus

## Oprawa ścienna-sufitowa SMD LED

cz: Svítidlo přisazené SMD LED / sk: Nástenné-stropné SMD LED svietidlo

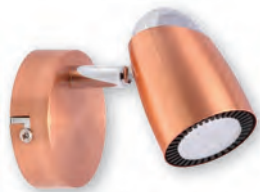

1 RUDA LED 1C 3000K



2 RUDA LED 2L 3000K



3 RUDA LED 3I 3000K

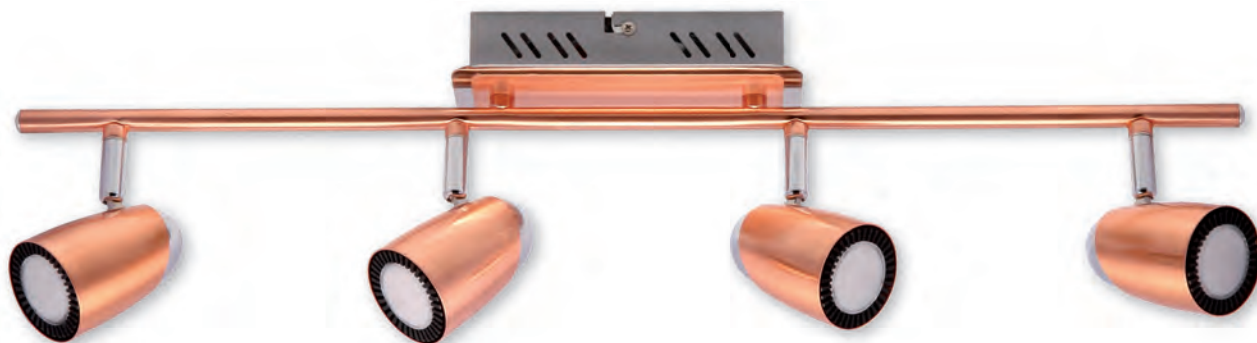

4 RUDA LED 4I 3000K

220-240V~	SMD LED		
3000K	120°	CRI [Ra] >80	30000h
IP 20			0,5

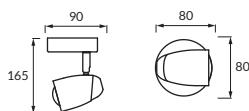

1 RUDA LED 1C 3000K

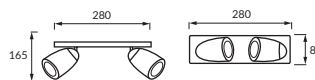

2 RUDA LED 2L 3000K

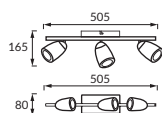

3 RUDA LED 3I 3000K

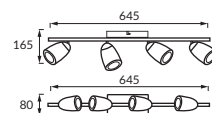

4 RUDA LED 4I 3000K

### Materiał / Materiál / Material

PL: stal nierdzewna, szkło  
CZ: nerezová ocel, sklo  
SK: nerezová ocel, sklo

### Uwagi / Komentář / Komentáre

PL: zasílac w komplecie  
CZ: napájecí zdroj je součástí dodávky  
SK: napájací zdroj je súčasťou dodávky

	01234	ABCDE					
1	02840	RUDA LED 1C 3000K	6 W	490 lm			5901477328404
2	02841	RUDA LED 2L 3000K	2 x 6 W	2 x 490 lm	miedziany+chrom	ciepłobiała	5901477328411
3	02842	RUDA LED 3I 3000K	3 x 6 W	3 x 490 lm	miedziany+chrom	teplá biela	5901477328428
4	02843	RUDA LED 4I 3000K	4 x 6 W	4 x 490 lm	medeny+chróm	teplá biela	5901477328435



PL: W skład oprawy wchodzi wbudowane lampy LED  
CZ: Toto svítidlo obsahuje zabudované svetelné zdroje LED  
SK: Toto svietidlo obsahuje zabudované svetelné zdroje LED

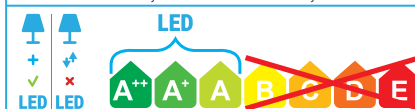

PL: Nie można wymieniać lamp w oprawie  
CZ: Svetelné zdroje v tomto svietidle nelze vymeniť  
SK: Svetelné zdroje v svietidle sa nedajú vymeniť



1 PARIS G9 1D



2 PARIS G9 2L

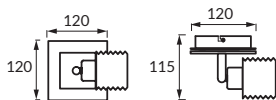

1 PARIS G9 1D

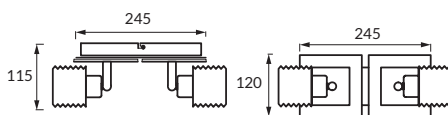

2 PARIS G9 2L

220-240V~	G9	G9	180°
100	2000h		20
	0,5		

**Materiał / Materiál / Material**

PL: stal nierdzewna, szkło

cz: nerezová ocel, sklo

sk: nerezová ocel, sklo

1	03054	PARIS G9 1D	max 40 W	590 lm	chrom+wenge chrom+wenge	5901477330544
2	03055	PARIS G9 2L	2 x max 40 W	2 x 590 lm	chróm+wenge	5901477330551

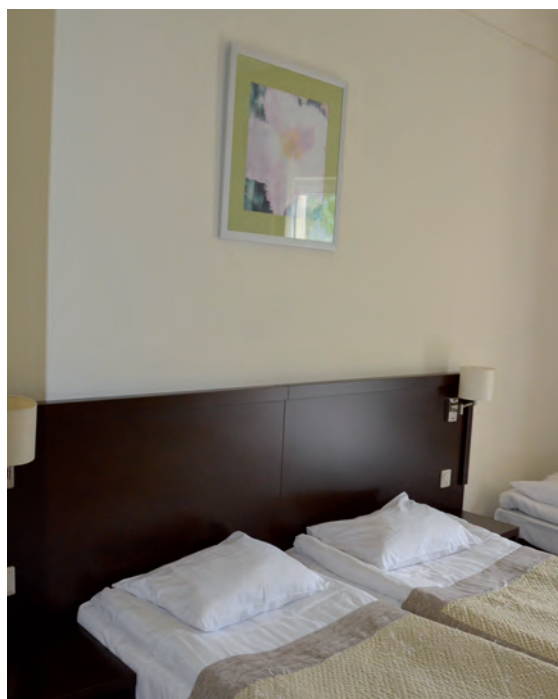

PL: Oprawa jest przystosowana do żarówek o klasach energetycznych:

cz: Toto svítidlo je kompatibilní s žárovkami energetické třídy:

sk: Toto svetidlo je kompatibilné so žiarovkami energetických tried:



PL: Oprawę sprzedaje się z żarówkami o klasie energetycznej C

cz: Toto svítidlo se prodává s žárovkami energetické třídy C

sk: Toto svetidlo sa predáva so žiarovkami energetickej triedy C



# KRISTIN G9

ideus

Oprawa ścienna-sufitowa

cz: Přisazené bodové svítidlo / sk: Nástenné-stropné svetidlo



1 KRISTIN G9 1D



2 KRISTIN G9 2L



3 KRISTIN G9 3L



4 KRISTIN G9 4D

220-240V~	G9	G9	180°
CRI	[Ra]	2000h	IP
100	2000h	20	
	0,5		

**Materiál / Material / Material**

PL: stal nierdzewna, szkło

CZ: nerezová ocel, sklo

SK: nerezová ocel, sklo

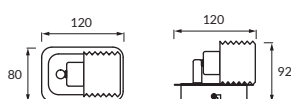

1 KRISTIN G9 1D

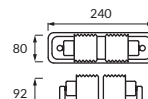

2 KRISTIN G9 2L

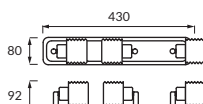

3 KRISTIN G9 3L

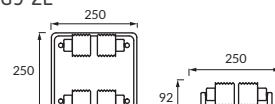

4 KRISTIN G9 4D

	01234					
1	02986	KRISTIN G9 1D	max 40 W	590 lm	chrom+biały chrom+biłá chróm+biely	5901477329869
2	02987	KRISTIN G9 2L	2 x max 40 W	2 x 590 lm		5901477329876
3	02988	KRISTIN G9 3L	3 x max 40 W	3 x 590 lm		5901477329883
4	02989	KRISTIN G9 4D	4 x max 40 W	4 x 590 lm		5901477329890



PL: Oprawa jest przystosowana do żarówek o klasach energetycznych:

CZ: Toto svítidlo je kompatibilní s žárovkami energetické třídy:

SK: Toto svetidlo je kompatibilné so žiarovkami energetických tried:



PL: Oprawa sprzedaje się z żarówkami o klasie energetycznej C

CZ: Toto svítidlo se prodává s žárovkami energetické třídy C

SK: Toto svetidlo sa predáva so žiarovkami energetickéj triedy C



1 EPOS G9 1D



2 EPOS G9 2L



3 EPOS G9 3L



4 EPOS G9 4L

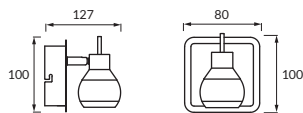

1 EPOS G9 1D

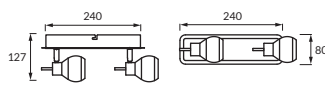

2 EPOS G9 2L

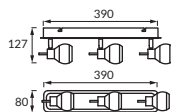

3 EPOS G9 3L

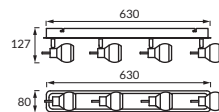

4 EPOS G9 4L

220-240V~	G9	G9	180°
100	2000h		IP 20
	0,5		

**Materiał / Materiál / Material**

PL: stal nierdzewna, szkło

cz: nerezová ocel, sklo

sk: nerezová ocel, sklo

1	02777	EPOS G9 1D	max 40 W	590 lm	chrom+wenge chrom+wenge chróm+wenge	5901477327773
2	02778	EPOS G9 2L	2 x max 40 W	2 x 590 lm		5901477327780
3	02779	EPOS G9 3L	3 x max 40 W	3 x 590 lm		5901477327797
4	02835	EPOS G9 4L	4 x max 40 W	4 x 590 lm		5901477328350

PL: Oprawa jest przystosowana do żarówek o klasach energetycznych:

cz: Toto svítidlo je kompatibilní s žárovkami energetické třídy:

sk: Toto svietidlo je kompatibilné so žiarovkami energetických tried:



PL: Oprawa sprzedaje się z żarówkami o klasie energetycznej C

cz: Toto svítidlo se prodává s žárovkami energetické třídy C

sk: Toto svietidlo sa predáva so žiarovkami energetickej triedy C

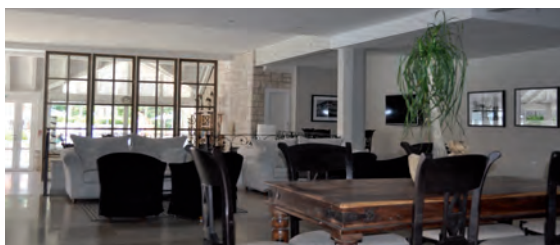

# KEMER HL71x

ideus

Oprawa ścienna-sufitowa

cz: Přisazené bodové svítidlo / sk: Nástenné-stropné svetidlo



① KEMER-1 HL715 CHROME



② KEMER-2 HL716 CHROME



③ KEMER-3 HL717 CHROME



⑤ KEMER-5 HL719 CHROME



④ KEMER-4 HL718 CHROME

220-240V~	G9	G9	180°
CRI 100	2000h		IP 20
	0,5		

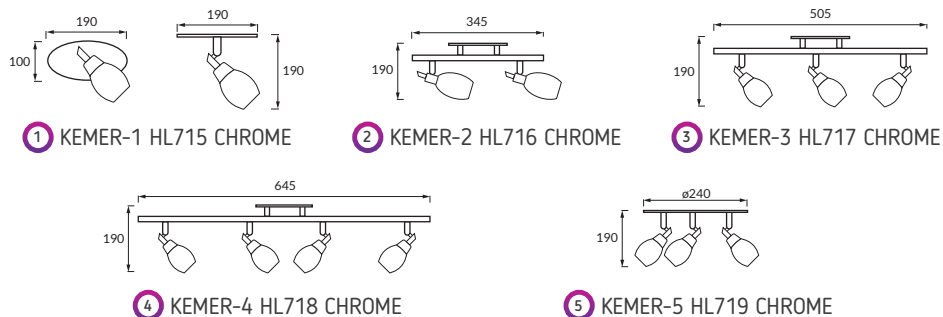

**Materiał / Materiál / Material**

PL: stal nierdzewna, szkło

CZ: nerezová ocel, sklo

SK: nerezová ocel, sklo

	01234	ABCDE				
1	00554	KEMER-1 HL715 CHROME	max 40 W	590 lm		5901477305542
2	00555	KEMER-2 HL716 CHROME	2 x max 40 W	2 x 590 lm	chrom	5901477305559
3	00556	KEMER-3 HL717 CHROME	3 x max 40 W	3 x 590 lm	chrom	5901477305566
4	00557	KEMER-4 HL718 CHROME	4 x max 40 W	4 x 590 lm	chróm	5901477305573
5	00558	KEMER-5 HL719 CHROME	3 x max 40 W	3 x 590 lm		5901477305580

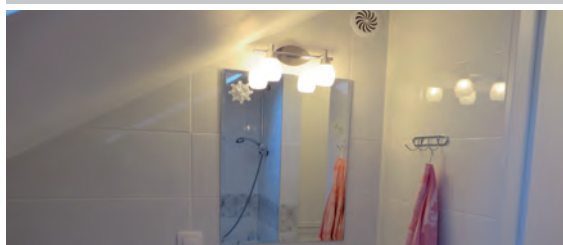

PL: Oprawa jest przystosowana do żarówek o klasach energetycznych:

CZ: Toto svítidlo je kompatibilní s žárovkami energetické třídy:

SK: Toto svetidlo je kompatibilné so žiarovkami energetických tried:



PL: Oprawę sprzedaje się z żarówkami o klasie energetycznej C

CZ: Toto svítidlo se prodává s žárovkami energetické třídy C

SK: Toto svetidlo sa predáva so žiarovkami energetickéj triedy C





1 KOMBI GU10 1C



2 KOMBI GU10 2L



3 KOMBI GU10 3L



4 KOMBI GU10 4D

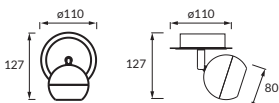

1 KOMBI GU10 1C

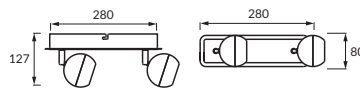

2 KOMBI GU10 2L

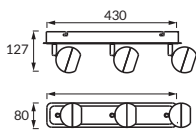

3 KOMBI GU10 3L

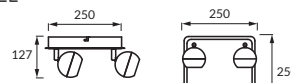

4 KOMBI GU10 4D

220-240V~	GU10	GU10	
IP 20		0,5	

CE

Material / Materiál / Material

PL: stal nierdzewna

CZ: nerezová ocel

SK: nerezová ocel

1	02836	KOMBI GU10 1C	max 35 W	czarny+biały černá+bilá čierna+biely	5901477328367
2	02837	KOMBI GU10 2L	2 x max 35 W		5901477328374
3	02838	KOMBI GU10 3L	3 x max 35 W		5901477328381
4	02839	KOMBI GU10 4D	4 x max 35 W		5901477328398

PL: Oprawa jest przystosowana do żarówek o klasach energetycznych:

CZ: Toto svítidlo je kompatibilní s žárovkami energetické třídy:

SK: Toto svetidlo je kompatibilné so žiarovkami energetických tried:

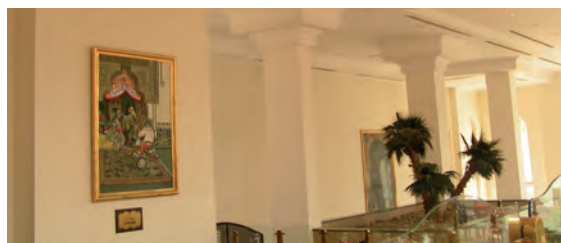
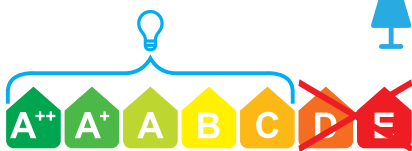

# MANAVGAT HL79xN

## Oprawa ścienna-sufitowa

cz: Přisazené bodové svítidlo / sk: Nástenné-stropné svetidlo



1 MANAVGAT-1 HL790N CHROME



2 MANAVGAT-2 HL791N CHROME



3 MANAVGAT-3 HL792N CHROME



5 MANAVGAT-5 HL794N CHROME



4 MANAVGAT-4 HL793N CHROME

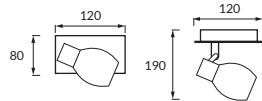
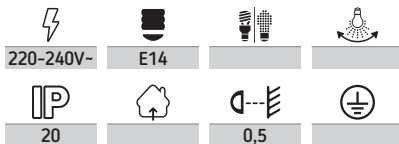

1 MANAVGAT-1 HL790N CHROME

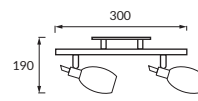

2 MANAVGAT-2 HL791N CHROME

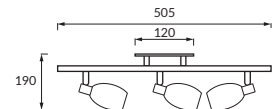

3 MANAVGAT-3 HL792N CHROME

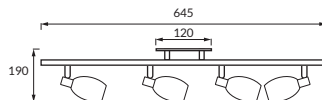

4 MANAVGAT-4 HL793N CHROME

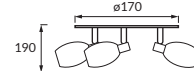

5 MANAVGAT-5 HL794N CHROME

### Materiał / Materiál / Material

PL: stal nierdzewna, szkło

CZ: nerezová ocel, sklo

SK: nerezová ocel, sklo

	01234	ABCDE			
1	00592	MANAVGAT-1 HL790N CHROME	max 9 W		5901477305924
2	00594	MANAVGAT-2 HL791N CHROME	2 x max 9 W	chrom	5901477305948
3	00596	MANAVGAT-3 HL792N CHROME	3 x max 9 W	chrom	5901477305962
4	00598	MANAVGAT-4 HL793N CHROME	4 x max 9 W	chróm	5901477305986
5	00599	MANAVGAT-5 HL794N CHROME	3 x max 9 W		5901477305993

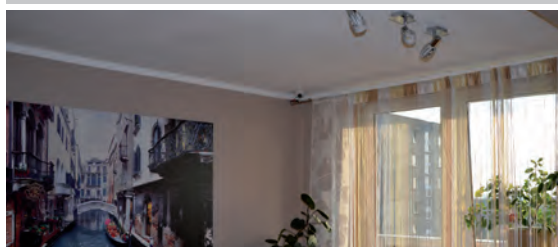

PL: Oprawa jest przystosowana do żarówek o klasach energetycznych:  
 cz: Toto svítidlo je kompatibilní s žárovkami energetické třídy:  
 sk: Toto svetidlo je kompatibilné so žiarovkami energetických tried.

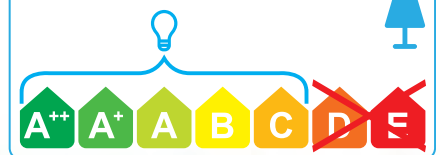



1 BODRUM-1 HL785N MATCHR



2 BODRUM-2 HL786N MATCHR



3 BODRUM-3 HL787N MATCHR



4 BODRUM-4 HL788N MATCHR

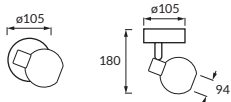

1 BODRUM-1 HL785N MATCHR

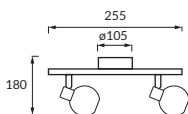

2 BODRUM-2 HL786N MATCHR

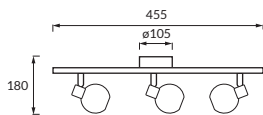

3 BODRUM-3 HL787N MATCHR

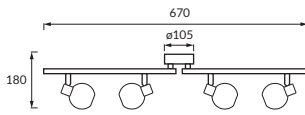

4 BODRUM-4 HL788N MATCHR

220-240V-	E14		
IP 20		0,5	
<b>CE</b>			

**Materiał / Materiál / Materiál**  
 PL: stal nierdzewna, szkło  
 cz: nerezová ocel, sklo  
 sk: nerezová ocel, sklo

	01234	ABCDE			
1	00584	BODRUM-1 HL785N MATCHR	max 9 W	matowy chrom matnýchrom matnýchróm	5901477305849
2	00586	BODRUM-2 HL786N MATCHR	2 x max 9 W		5901477305863
3	00588	BODRUM-3 HL787N MATCHR	3 x max 9 W		5901477305887
4	00590	BODRUM-4 HL788N MATCHR	4 x max 9 W		5901477305900

PL: Oprawa jest przystosowana do żarówek o klasach energetycznych:  
 cz: Toto svítidlo je kompatibilní s žárovkami energetické třídy:  
 sk: Toto svetidlo je kompatibilné so žiarovkami energetických tried:

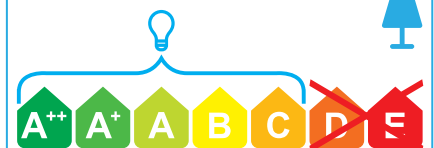



# DORI LED

## Lampka biurkowa SMD LED

cz: Kancelářská stolní lampka SMD LED / sk: Kancelárska stolná lampka SMD LED



1 DORI LED ORANGE



2 DORI LED RED



3 DORI LED BLUE



4 DORI LED GREEN



5 DORI LED ORANGE CLIP



6 DORI LED RED CLIP



7 DORI LED BLUE CLIP



8 DORI LED GREEN CLIP

220-240V-	6W	SMD LED	
4000K	480lm	140°	
>80	30000h		
IP 20		0,3	

**CE**

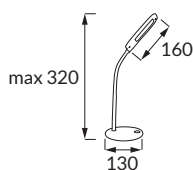

1 ... 4 DORI LED

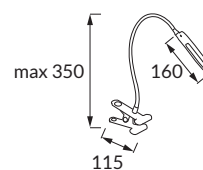

5 ... 8 DORI LED CLIP

	01234	ABCDE		
1	02786	DORI LED ORANGE	pomarańczowy / oranżowy / oranżowy	5901477327865
2	02787	DORI LED RED	czerwony / červená / červená	5901477327872
3	02788	DORI LED BLUE	niebieski / modrá / modrá	5901477327889
4	02789	DORI LED GREEN	zielony / zelený / zelený	5901477327896
5	02865	DORI LED ORANGE CLIP	pomarańczowy / oranżowy / oranżowy	5901477328657
6	02866	DORI LED RED CLIP	czerwony / červená / červená	5901477328664
7	02867	DORI LED BLUE CLIP	niebieski / modrá / modrá	5901477328671
8	02868	DORI LED GREEN CLIP	zielony / zelený / zelený	5901477328688

### Materiał / Materiál / Material

PL: stal nierdzewna, tworzywo sztuczne

CZ: nerezová ocel, plast

SK: nerezová ocel, plast

### Uwagi / Komentář / Kommentäre

PL: zasilacz w komplecie

CZ: napájecí zdroj je součástí dodávky

SK: napájací zdroj je súčasťou dodávky



PL: W skład oprawy wchodzi wbudowane lampy LED  
 CZ: Toto svítidlo obsahuje zabudované světelné zdroje LED  
 SK: Toto svietidlo obsahuje zabudované svetelné zdroje LED

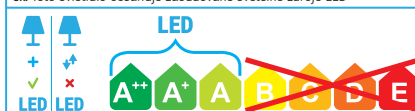

PL: Nie można wymieniać lamp w oprawie

CZ: Světelné zdroje v tomto svítidle nelze vyměnit

SK: Svetelné zdroje v svietidle sa nedajú vymeniť



1 RONI LED BLUE



2 RONI LED PINK



3 RONI LED GREEN



4 RONI LED WHITE CLIP



5 RONI LED SILVER CLIP



6 RONI LED BLACK CLIP

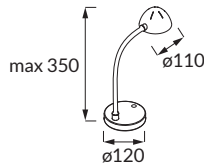

1 ... 3 RONI LED

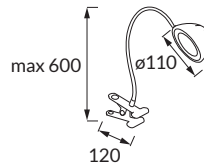

4 ... 6 RONI LED CLIP

220-240V-	4W	SMD LED	
	4000K	248lm	90°
>80	30000h		
IP 20		0,3	

**CE**

	01234	ABCDE			
1	02873	RONI LED BLUE	niebieski / modrá / modrá	neutralna biała neutrální bílá neutrálna biela	5901477328732
2	02874	RONI LED PINK	różowy / růžová / ružový		5901477328749
3	02875	RONI LED GREEN	zielony / zelený / zeleny		5901477328756
4	02923	RONI LED WHITE CLIP	biały / bílá / biely		5901477329234
5	02876	RONI LED SILVER CLIP	srebrny / stříbrná / strieborná		5901477328763
6	02877	RONI LED BLACK CLIP	czarny / černá / čierna		5901477328770

**Materiał / Materiál / Material**  
 PL: stal nierdzewna, ABS  
 CZ: nerezová ocel, ABS  
 SK: nerezová ocel, ABS

**Uwagi / Komentář / Komentáre**  
 PL: zasilacz w komplecie  
 CZ: napájecí zdroj je součástí dodávky  
 SK: napájací zdroj je súčasťou dodávky

PL: W skład oprawy wchodzi wbudowane lampy LED  
 CZ: Toto svítidlo obsahuje zabudované světelné zdroje LED  
 SK: Toto svietidlo obsahuje zabudované svetelné zdroje LED

**LED**

A+ A A B C D E

PL: Nie można wymieniać lamp w oprawie  
 CZ: Světelné zdroje v tomto svítidle nelze vyměnit  
 SK: Svetelné zdroje v svietidle sa nedajú vymeniť

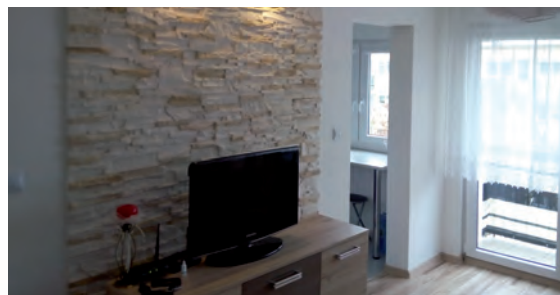

# IREM LED

## Lampka biurkowa SMD LED

cz: Kancelářská stolní lampka SMD LED / sk: Kancelárska stolná lampka SMD LED



1 IREM LED WHITE

2 IREM LED RED

3 IREM LED BLACK



220-240V-	5W	SMD LED	
4500K	300lm	120°	CRI (Ra) >80
30000h			IP 20

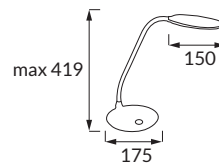

1...3 IREM LED

### Materiał / Materiál / Material

PL: stal nierdzewna, ABS

CZ: nerezová ocel, ABS

SK: nerezová ocel, ABS

### Uwagi / Komentář / Komentáre

PL: zasilacz w komplecie

CZ: napájecí zdroj je součástí dodávky

SK: napájací zdroj je súčasťou dodávky

### Uwagi / Komentář / Komentáre

PL: trzystopniowa regulacja jasności

CZ: trojstupňová úprava jasu

SK: trístupňová úprava jasu

### Uwagi / Komentář / Komentáre

PL: włącznik dotykowy

CZ: dotykový spínač

SK: dotykový spínač

### Uwagi / Komentář / Komentáre

PL: szkło powiększające

CZ: zvětšovací sklo

SK: zväčšovacie sklo

	01234	ABCDE			
1	02938	IREM LED WHITE	biały / bílá / biely	neutralna biała	5901477329388
2	02939	IREM LED RED	czerwony / červená / červená	neutrální bílá	5901477329395
3	02940	IREM LED BLACK	czarny / černá / čierna	neutrálna biela	5901477329401



PL: W skład oprawy wchodzi wbudowane lampy LED  
 CZ: Toto svítidlo obsahuje zabudované světelné zdroje LED  
 SK: Toto svietidlo obsahuje zabudované svetelné zdroje LED



PL: Nie można wymienić lamp w sprawie  
 CZ: Světelné zdroje v tomto svítidle nelze vyměnit  
 SK: Svetelné zdroje v svietidle sa nedajú vymeniť





1 TOLA E27 WHITE



2 TOLA E27 RED



3 TOLA E27 BLUE



4 TOLA E27 SILVER



5 TOLA E27 WHITE CLIP



6 TOLA E27 RED CLIP



7 TOLA E27 BLUE CLIP



8 TOLA E27 SILVER CLIP

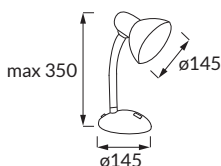

1...4 TOLA E27

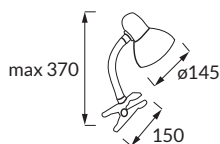

5...8 TOLA E27 CLIP

220-240V-	max 40W	E27	
		IP 20	
0,3			

**Materiał / Materiál / Material**

- PL: blacha stalowa, tworzywo sztuczne
- CZ: kovový výlisek, plast
- SK: kovový výlisok, plast

	01234	ABCDE		
1	02849	TOLA E27 WHITE	biały / bílá / biely	5901477328497
2	02850	TOLA E27 RED	czerwony / červená / červená	5901477328503
3	02851	TOLA E27 BLUE	niebieski / modrá / modrá	5901477328510
4	02852	TOLA E27 SILVER	srebrny / stříbrná / stříborná	5901477328527
5	02853	TOLA E27 WHITE CLIP	biały / bílá / biely	5901477328534
6	02854	TOLA E27 RED CLIP	czerwony / červená / červená	5901477328541
7	02855	TOLA E27 BLUE CLIP	niebieski / modrá / modrá	5901477328558
8	02856	TOLA E27 SILVER CLIP	srebrny / stříbrná / stříborná	5901477328565

PL: Oprawa jest przystosowana do żarówek o klasach energetycznych:  
 CZ: Toto svítidlo je kompatibilní s žárovkami energetické třídy:  
 SK: Toto svetidlo je kompatibilné so žiarovkami energetických tried:

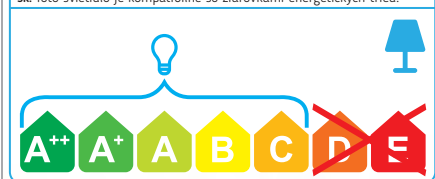

# KATI E27

## Lampka biurkowa

**CZ:** Kancelářská stolní lampa / **SK:** Kancelárská stolná lampa



1 KATI E27 WHITE



3 KATI E27 BLUE



2 KATI E27 RED



4 KATI E27 GREEN



5 KATI E27 WHITE CLIP



7 KATI E27 BLUE CLIP



6 KATI E27 RED CLIP



8 KATI E27 GREEN CLIP

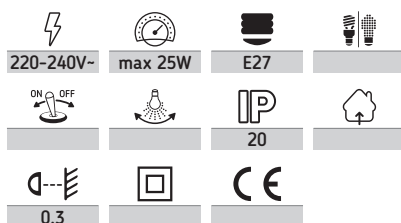

1...4 KATI E27



5...8 KATI E27 CLIP

**Materiał / Materiál / Materiál**  
 PL: stal nierdzewna, tworzywo sztuczne  
 CZ: nerezová ocel, plast  
 SK: nerezová ocel, plast

	01234	ABCDE		
1	02857	KATI E27 WHITE	biały / biła / biely	5901477328572
2	02858	KATI E27 RED	czerwony / červená / červená	5901477328589
3	02859	KATI E27 BLUE	niebieski / modrá / modrá	5901477328596
4	02860	KATI E27 GREEN	zielony / zelený / zeleny	5901477328602
5	02861	KATI E27 WHITE CLIP	biały / biła / biely	5901477328619
6	02862	KATI E27 RED CLIP	czerwony / červená / červená	5901477328626
7	02863	KATI E27 BLUE CLIP	niebieski / modrá / modrá	5901477328633
8	02864	KATI E27 GREEN CLIP	zielony / zelený / zeleny	5901477328640



PL: Oprawa jest przystosowana do żarówek o klasach energetycznych:  
 CZ: Toto svietidlo je kompatibilní s žárovkami energetické třídy:  
 SK: Toto svietidlo je kompatibilné so žiarovkami energetických tried.

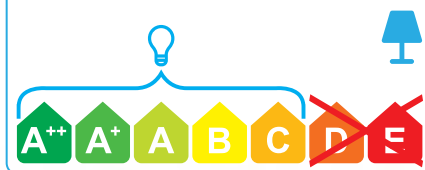



1 KITTY HL036 BLUE



2 KITTY HL036 GREEN



3 KITTY HL036 PINK

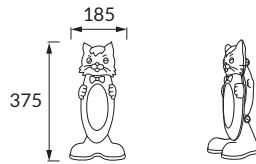

1...3 KITTY HL036

	01234	ABCDE			
1	00665	KITTY HL036 BLUE	niebieski / modrá / modrá	zimnobiała studená biela	5901477306655
2	00664	KITTY HL036 GREEN	zielony / zelený / zeleny	zimnobiała studená biela	5901477306648
3	00666	KITTY HL036 PINK	różowy / růžová / ružový	zimnobiała studená biela	5901477306662

220-240V-	11W	G23	PL
$\triangle$	Tc (K) 6500K	900lm	160°
8000h	ON OFF		IP 20
	0,3		

**Materiał / Materiál / Material**

PL: tworzywo sztuczne

CZ: plast

SK: plast

**Uwagi / Komentář / Komentáre**

PL: balast elektroniczny (EVG) w komplecie

CZ: elektronický druh předřadníku (EVG) součástí dodávky

SK: elektronický druh predradníka (EVG) súčasť dodávky

PL: Oprawa jest przystosowana do żarówek o klasach energetycznych:  
 CZ: Toto svítidlo je kompatibilní s žárovkami energetické třídy:  
 SK: Toto svietidlo je kompatibilné so žiarovkami energetických tried:



PL: Oprawę sprzedaje się z lampą o klasie energetycznej A  
 CZ: Toto svítidlo se prodává se světelným zdrojem energetické třídy A  
 SK: Toto svietidlo sa predáva so svetelným zdrojom energetickej triedy A





# MOLLY HL037

ideus

Lampka biurkowa dziecięca

cz: Stolní lampa pro děti / sk: Stolná lampa pre deti



1 MOLLY HL037 BLUE



2 MOLLY HL037 GREEN



3 MOLLY HL037 PINK

220-240V-	11W	G23	PL
<b>Tc Iki</b>	6500K	900lm	160°
8000h	ON OFF		IP 20
	0,3		

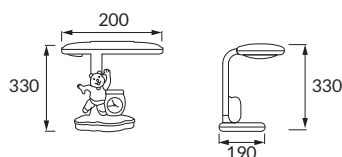

1...3 MOLLY HL037

## Materiał / Materiál / Material

PL: tworzywo sztuczne

CZ: plast

SK: plast

## Uwagi / Komentář / Komentáre

PL: balast elektroniczny (EVG) w komplecie

CZ: elektronický druh předřadníku (EVG) součástí dodávky

SK: elektronický druh predradníka (EVG) súčasť dodávky

	01234	ABCDE			
1	00668	MOLLY HL037 BLUE	niebieski / modrá / modrá	zimmnobiała	5901477306686
2	00667	MOLLY HL037 GREEN	zielony / zelený / zeleny	studená bílá	5901477306679
3	00669	MOLLY HL037 PINK	różowy / růžová / ružový	studená biela	5901477306693



PL: Oprawa jest przystosowana do żarówek o klasach energetycznych:

CZ: Toto svítidlo je kompatibilní s žárovkami energetické třídy:

SK: Toto svietidlo je kompatibilné so žiarovkami energetických tried:



PL: Oprawę sprzedaje się z lampą o klasie energetycznej A

CZ: Toto svítidlo se prodává se světelným zdrojem energetické třídy A

SK: Toto svietidlo sa predáva so svetelným zdrojom energetické triedy A



1 DONALD HLO43 BLUE



2 DONALD HLO43 GREEN



3 DONALD HLO43 ORANGE

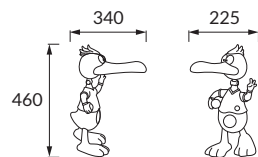

1 2 3 DONALD HLO43

	01234	ABCDE			
1	00687	DONALD HLO43 BLUE	niebieski / modrá / modrá	zimmobiała studená biła	5901477306877
2	00685	DONALD HLO43 GREEN	zielony / zelený / zeleny	zimmobiała studená biła	5901477306853
3	00686	DONALD HLO43 ORANGE	pomarańczowy / oranżowy / oranžový	zimmobiała studená biła	5901477306860

⚡	⌚	⏏	✓
220-240V~	11W	G23	PL
⚡	Tc (K)	💡	🌀
	6500K	900lm	160°
🕒	ON OFF	🌀	IP
8000h			20
♻️	0,3	☐	CE

**Materiał / Materiál / Material**

PL: tworzywo sztuczne

CZ: plast

SK: plast

**Uwagi / Komentář / Komentáre**

PL: balast elektroniczny (EVG) w komplecie

CZ: elektronický druh předřadníku (EVG) součástí dodávky

SK: elektronický druh predradníku (EVG) súčasť dodávky



PL: Oprawa jest przystosowana do żarówek o klasach energetycznych:

CZ: Toto svítidlo je kompatibilní s žárovkami energetické třídy:

SK: Toto svietidlo je kompatibilné so žiarovkami energetických tried:



PL: Oprawa sprzedaje się z lampą o klasie energetycznej A

CZ: Toto svítidlo se prodává se světelným zdrojem energetické třídy A

SK: Toto svietidlo sa predáva so svetelným zdrojom energetickej triedy A

# DEO / MYS / EGO / SIMPSON HL981L

## Lampka wtykowa LED

cz: Zásuvková lampička LED / sk: Zásuvková lampička LED



1 DEO LED 1W



2 MYS LED 0,5W



3 EGO LED 0,5W



4 SIMPSON HL981L WHITE

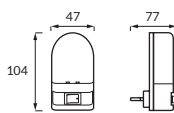
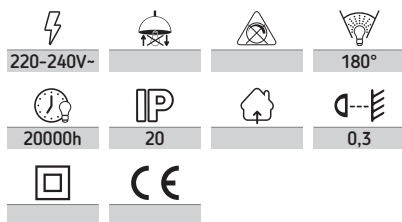

1 DEO LED 1W

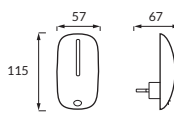

2 MYS LED 0,5W

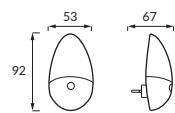

3 EGO LED 0,5W

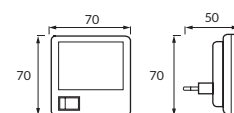

4 SIMPSON HL981L WHITE

	01234	ABCDE								
1	02869	DEO LED 1W	1 W	8 DIP LED	64 lm	biały biłá biely	zimnobiała studená biłá studená biela	×	✓	5901477328695
2	02870	MYS LED 0,5W	0,5 W	5 DIP LED	30 lm			✓	×	5901477328701
3	02790	EGO LED 0,5W	0,5 W	4 DIP LED	12 lm			×	✓	5901477327902
4	02554	SIMPSON HL981L WHITE	0,4 W	4 DIP LED	9,2 lm			mix / mix / mix	×	✓

### Materiał / Materiál / Material

PL: tworzywo sztuczne

CZ: plast

SK: plast

### 2 MYS LED 0,5W

### Uwagi / Komentář / Komentáre

PL: czujnik zmierzchowy

CZ: soumrakový spínač

SK: súmrakový spínač



PL: W skład oprawy wchodzi wbudowane lampy LED  
 CZ: Toto svítidlo obsahuje zabudované světelné zdroje LED  
 SK: Toto svietidlo obsahuje zabudované svetelné zdroje LED

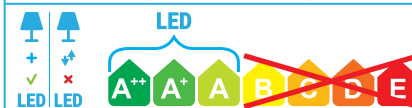

PL: Nie można wymieniać lamp w oprawie

CZ: Světelné zdroje v tomto svítidle nelze vyměnit

SK: Svetelné zdroje v svietidle sa nedajú vymeniť





1 DORA HL990L WIEZA

2 REX HL991L SLONCE

3 BUGS HL992L SERCE

4 MAX HL993L ROZA

5 DUFFY HL994L MOTYL

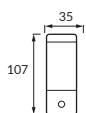

1 DORA HL990L WIEZA

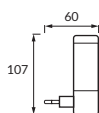

2 REX HL991L SLONCE

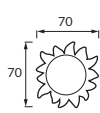

3 BUGS HL992L SERCE

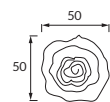
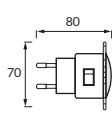

4 MAX HL993L ROZA

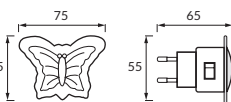
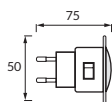

5 DUFFY HL994L MOTYL

220-240V-			2,3 lm/LED
180°	20000h		IP 20
	0,3		

**Materiał / Materiál / Material**

PL: tworzywo sztuczne

CZ: plast

SK: plast

**Uwagi / Komentář / Komentáre**

PL: przy zakupie otrzymuje się losowo wybrany kolor świecenia

CZ: při nákupu je farba svetla náhodná

SK: při nákupu je farba svetla náhodná

	01234	ABCDE				
1	02321	DORA HL990L WIEZA	0,4 W	4 DIP LED	biały biłá biely	5901477323218
2	02261	REX HL991L SLONCE				5901477322617
3	02250	BUGS HL992L SERCE	0,3 W	3 DIP LED		5901477322501
4	02252	MAX HL993L ROZA	0,4 W	4 DIP LED		5901477322525
5	02251	DUFFY HL994L MOTYL	0,3 W	3 DIP LED		5901477322518



PL: W skład oprawy wchodzi wbudowane lampy LED  
 cz: Toto svítidlo obsahuje zabudované světelné zdroje LED  
 sk: Toto svietidlo obsahuje zabudované svetelné zdroje LED



PL: Nie można wymieniać lamp w oprawie  
 cz: Světelné zdroje v tomto svítidle nelze vyměnit  
 sk: Svetelné zdroje v svietidle sa nedajú vymeniť





1 WARTE 60 BLACK

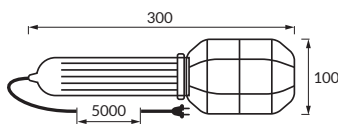

1 WARTE 60 BLACK

220-240V~	max 60W	E27	
IP 20		0,5	

**Materiał / Materiál / Materiál**

PL: guma, stal  
 cz: pryż, ocel  
 sk: pryż, ocel

**Uwagi / Komentář / Komentáre**

PL: przewód z wtyczką 5 m  
 cz: přívod s vidlicí 5 m  
 sk: prívod s vidlicou 5 m

	01234	ABCDE		
1	02677	WARTE 60 BLACK	czarny černá čierna	5901477326776



PL: Oprawa jest przystosowana do żarówek o klasach energetycznych:  
 cz: Toto svítidlo je kompatibilní s žárovkami energetické třídy:  
 sk: Toto svietidlo je kompatibilné so žiarovkami energetických tried:

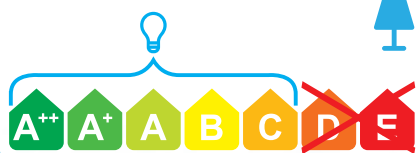



# ZICO HL31xL

## Oprawa akumulatorowa LED

cz: Akumulátorová svítlna LED / sk: Akumulátorové svetidlo LED



① ZICO-6 HL312L LED60



② ZICO-4 HL313L LED32

0,10 W/LED	6500K	110°
>80	20000h	IP20
0,3		

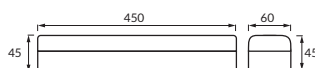

① ZICO-6 HL312L LED60

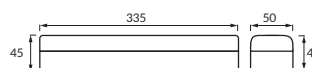

② ZICO-4 HL313L LED32

### Materiał / Materiál / Material

PL: tworzywo sztuczne

CZ: plast

SK: plast

	01234	ABCDE						
1	01769	ZICO-6 HL312L LED60	4x4V 1Ah	60 DIP LED	60 x 1500MCD	biały	zimnobiała	5901477317699
2	01770	ZICO-4 HL313L LED32	4V 1,6Ah	32 DIP LED	32 x 1500MCD	biely	studená biela	5901477317705

### ⚠ Uwagi / Komentář / Kommentäre

PL: akumulator w komplecie

CZ: baterie součástí dodávky

SK: batéria súčasťou dodávky

### ⚠ Uwagi / Komentář / Kommentäre

PL: podczas ładowania oprawa nie świeci

CZ: po dobu nabíjania svetidlo nesvieti

SK: po dobu nabíjania svítlna nesvietí

### ⚠ Uwagi / Komentář / Kommentäre

PL: czas ładowania akumulatora 15h

CZ: čas nabíjení akumulátoru 15h

SK: doba nabíjania akumulátora 15h

### ① ZICO-6 HL312L LED60

### ⚠ Uwagi / Komentář / Kommentäre

PL: czas świecenia dla jednego ładowania max 4h

CZ: doba svícení na jedno nabití max 4h

SK: doba svietenia na jedno nabitie max 4h

### ② ZICO-4 HL313L LED32

### ⚠ Uwagi / Komentář / Kommentäre

PL: czas świecenia dla jednego ładowania max 3h

CZ: doba svícení na jedno nabití max 3h

SK: doba svietenia na jedno nabitie max 3h





1 SIGMA-4 HL2001L 4W



2 SIGMA-7 HL2001L 7W



3 SIGMA-10 HL2001L 10W

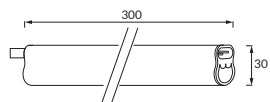

1 SIGMA-4 HL2001L 4W



2 SIGMA-7 HL2001L 7W

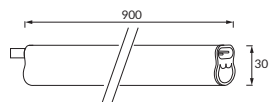

3 SIGMA-10 HL2001L 10W

Icon	Barcode	Model	Power	Lumen	Color	Temperature	Barcode
1	01234	SIGMA-4 HL2001L 4W	4 W	360 lm	biały	zimnobiała	5901477326899
2	02690	SIGMA-7 HL2001L 7W	7 W	630 lm	biłá	studená biłá	5901477326905
3	02691	SIGMA-10 HL2001L 10W	10 W	900 lm	biely	studená biela	5901477326912

⚡	✓	☑	⚠
220-240V~	SMD LED		
Tc (K) SMD56	6500K	45°	CRI [Ra] >80
			20000h
P		0,3	
20			

CE

🌐	<b>Materiał / Materiál / Material</b>
PL:	tworzywo sztuczne
CZ:	plast
SK:	plast

⚠	<b>Uwagi / Komentář / Komentáre</b>
PL:	zasilacz w komplecie
CZ:	napájecí zdroj je součástí dodávky
SK:	napájací zdroj je súčasťou dodávky



PL: W skład oprawy wchodzi wbudowane lampy LED  
 CZ: Toto svítidlo obsahuje zabudované světelné zdroje LED  
 SK: Toto svietidlo obsahuje zabudované svetelné zdroje LED

LED

A++ A+ A B C D E

PL: Nie można wymieniać lamp w oprawie  
 CZ: Světelné zdroje v tomto svítidle nelze vyměnit  
 SK: Svetelné zdroje v svietidle sa nedajú vymeniť

# ALFA HL2001

## Podszafkowa oprawa liniowa

cz: Nábytkové zářivkové svítidlo / sk: Nábytkové žiarivkové svietidlo



1 ALFA-8 HL2001 8W

2 ALFA-13 HL2001 13W

3 ALFA-21 HL2001 21W

220-240V~	G5	T5	
6500K	160°	5000h	
20		0,5	

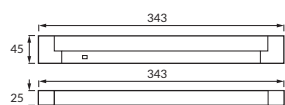

1 ALFA-8 HL2001 8W

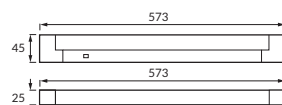

2 ALFA-13 HL2001 13W

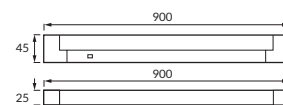

3 ALFA-21 HL2001 21W

1	01234	ABCDE	8 W	360 lm	biały	zimnobiała	5901477308482
2	00848	ALFA-8 HL2001 8W	13 W	585 lm	biła	studená biła	5901477308499
3	00849	ALFA-13 HL2001 13W	21 W	945 lm	biely	studená biela	5901477308505

### Materiał / Materiál / Materiál

PL: tworzywo sztuczne

CZ: plast

SK: plast

### Uwagi / Komentář / Komentáre

PL: balast elektroniczny (EVG) w komplecie

CZ: elektronický druh předradníku (EVG) součástí dodávky

SK: elektronický druh predradníka (EVG) súčasť dodávky



PL: W skład oprawy wchodzi wbudowane lampy LED  
 CZ: Toto svítidlo obsahuje zabudované světelné zdroje LED  
 SK: Toto svietidlo obsahuje zabudované svetelné zdroje LED

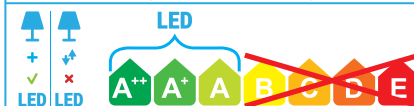

PL: Nie można wymieniać lamp w oprawie

CZ: Světelné zdroje v tomto svítidle nelze vyměnit

SK: Svetelné zdroje v svietidle sa nedajú vymeniť





1 3 5 7 LATE LED..WW



2 4 6 8 LATE LED..CW

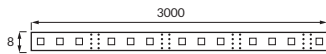

1 ... 4 LATE LED 3m

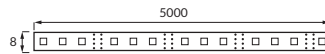

5 ... 8 LATE LED 5m

12V DC			140°
CRI >80	25000h	0,5	

01234	ABCDE									
1	03022	LATE LED 3m 180 WW	14,4 W	1260 lm	180 SMD LED 28x35	biały biła biely	ciepłobiała / teplá bilá / teplá biela	3000K	20	5901477330223
2	03023	LATE LED 3m 180 CW					zimmobiała / studená biła / studená biela	6500K	20	5901477330230
3	03024	LATE LED 3m 180 WW IP65					ciepłobiała / teplá biła / teplá biela	3000K	65	5901477330247
4	03025	LATE LED 3m 180 CW IP65					zimmobiała / studená biła / studená biela	6500K	65	5901477330254
5	03026	LATE LED 5m 300 WW	24 W	2100 lm	300 SMD LED 28x35	ciepłobiała / teplá biła / teplá biela	3000K	20	5901477330261	
6	03027	LATE LED 5m 300 CW				zimmobiała / studená biła / studená biela	6500K	20	5901477330278	
7	03028	LATE LED 5m 300 WW IP65				ciepłobiała / teplá biła / teplá biela	3000K	65	5901477330285	
8	03029	LATE LED 5m 300 CW IP65				zimmobiała / studená biła / studená biela	6500K	65	5901477330292	



<b>Materiał / Materiál / Materiál</b> PL: FR-4 CZ: FR-4 SK: FR-4	<b>Uwagi / Komentář / Komentáre</b> PL: możliwość cięcia co 3 LED CZ: možnost dělení na části 3 LED SK: možnosť' delenia na segmenty 3 LED
<b>Uwagi / Komentář / Komentáre</b> PL: produkt dekoracyjny CZ: dekorační výrobek SK: dekoračné výrobok	<b>Uwagi / Komentář / Komentáre</b> PL: 60 SMD LED na 1 m CZ: 60 SMD LED na 1 m SK: 60 SMD LED na 1 m
1 ... 4 LATE LED 3m	5 ... 8 LATE LED 5m
<b>Uwagi / Komentář / Komentáre</b> PL: 3 m na rolce CZ: 3 m na navijáku SK: 3 m na navijaku	<b>Uwagi / Komentář / Komentáre</b> PL: 5 m na rolce CZ: 5 m na navijáku SK: 5 m na navijaku

PL: W skład oprawy wchodzi wbudowane lampy LED  
CZ: Toto svítidlo obsahuje zabudované světelné zdroje LED  
SK: Toto svietidlo obsahuje zabudované svetelné zdroje LED

PL: Nie można wymieniać lamp w oprawie  
CZ: Světelné zdroje v tomto svítidle nelze vyměnit  
SK: Svetelné zdroje v svietidle sa nedajú vymeniť

# LATE LED...BLISTER

## Taśmy LED

cz: LED pásy / sk: LED pásy



1 2 7 8 LATE LED..RGB



3 5 9 11 LATE LED..WW



4 6 10 12 LATE LED..CW



2 5 6 8 11 12 LATE LED..IP65



220-240V~			140°
25000h	0,5		



1 2 LATE LED 3m 90



3 ... 6 LATE LED 3m 180



7 8 LATE LED 5m 150



9 ... 12 LATE LED 5m 300

	01234	ABCDE											
1	03030	LATE LED 3m 90 RGB BLISTER	21,6 W	1080 lm	90 SMD LED 50x50	biały biła biely	wielokolorowa / vícebarevný / viacfarebný	20				5901477330308	
2	03031	LATE LED 3m 90 RGB BLISTER IP65					wielokolorowa / vícebarevný / viacfarebný	-	65				
3	03032	LATE LED 3m 180 WW BLISTER	14,4 W	1260 lm	180 SMD LED 28x35		ciepłobiała / teplá biła / teplá biela	3000K	20		>80	5901477330322	
4	03033	LATE LED 3m 180 CW BLISTER					zimnobiała / studená biła / studená biela	6500K	20		>80	5901477330339	
5	03034	LATE LED 3m 180 WW IP65 BLISTER					ciepłobiała / teplá biła / teplá biela	3000K	65		>80	5901477330346	
6	03035	LATE LED 3m 180 CW IP65 BLISTER					zimnobiała / studená biła / studená biela	6500K	65		>80	5901477330353	
7	03036	LATE LED 5m 150 RGB BLISTER	36 W	1800 lm	150 SMD LED 50x50		wielokolorowa / vícebarevný / viacfarebný	-	20			5901477330360	
8	03037	LATE LED 5m 150 RGB BLISTER IP65					wielokolorowa / vícebarevný / viacfarebný	-	65				
9	03038	LATE LED 5m 300 WW BLISTER	24 W	2100 lm	300 SMD LED 28x35		ciepłobiała / teplá biła / teplá biela	3000K	20		>80	5901477330384	
10	03039	LATE LED 5m 300 CW BLISTER					zimnobiała / studená biła / studená biela	6500K	20		>80	5901477330391	
11	03040	LATE LED 5m 300 WW IP65 BLISTER					ciepłobiała / teplá biła / teplá biela	3000K	65		>80	5901477330407	
12	03041	LATE LED 5m 300 CW IP65 BLISTER					zimnobiała / studená biła / studená biela	6500K	65		>80	5901477330414	

1 ... 12	1 ... 6 LATE LED 3m	7 ... 12 LATE LED 5m	1 2 7 8	3 4 5 6 9 10 11 12
<b>Materiał / Materiál / Materiál</b>	<b>Uwagi / Komentář / Komentáre</b>	<b>Uwagi / Komentář / Komentáre</b>	<b>Uwagi / Komentář / Komentáre</b>	<b>Uwagi / Komentář / Komentáre</b>
PL: FR-4	PL: 3 m na rolce	PL: 5 m na rolce	PL: 30 SMD LED na 1 m	PL: 60 SMD LED na 1 m
CZ: FR-4	CZ: 3 m na navijáku	CZ: 5 m na navijáku	CZ: 30 SMD LED na 1 m	CZ: 60 SMD LED na 1 m
SK: FR-4	SK: 3 m na navijaku	SK: 5 m na navijaku	SK: 30 SMD LED na 1 m	SK: 60 SMD LED na 1 m

**Uwagi / Komentář / Komentáre**  
 PL: możliwość cięcia co 3 LED  
 CZ: možnost dělení na části 3 LED  
 SK: možnosť delenia na segmenty 3 LED

**Uwagi / Komentář / Komentáre**  
 PL: produkt dekoracyjny  
 CZ: dekorální výrobek  
 SK: dekoračný výrobok

3 4 5 6 9 10 11 12

PL: W skład oprawy wchodzi wbudowane lampy LED  
 CZ: Toto svítidlo obsahuje zabudované světelné zdroje LED  
 SK: Toto svietidlo obsahuje zabudované svetelné zdroje LED

PL: Nie można wymieniać lamp w oprawie  
 CZ: Světelné zdroje v tomto svítidle nelze vyměnit  
 SK: Svetelné zdroje v svietidle sa nedajú vymeniť

1 2 7 8

PL: W skład oprawy wchodzi wbudowane lampy LED  
 CZ: Toto svítidlo obsahuje zabudované světelné zdroje LED  
 SK: Toto svietidlo obsahuje zabudované svetelné zdroje LED

PL: Nie można wymieniać lamp w oprawie  
 CZ: Světelné zdroje v tomto svítidle nelze vyměnit  
 SK: Svetelné zdroje v svietidle sa nedajú vymeniť



1 DELTA-18 HL160 18W



2 DELTA-36 HL161 36W



3 PUNTO-36 HL162 2X18W



4 PUNTO-72 HL163 2X36W

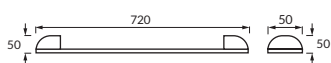

1 DELTA-18 HL160 18W

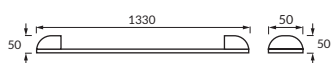

2 DELTA-36 HL161 36W

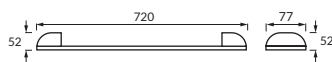

3 PUNTO-36 HL162 2X18W

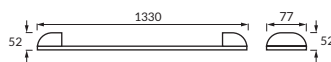

4 PUNTO-72 HL163 2X36W

Image	Code	Model	Power	Color	Barcode
	01234	ABCDE			
1	00841	DELTA-18 HL160 18W	18 W	biały biła biely	5901477308413
2	00842	DELTA-36 HL161 36W	36 W		5901477308420
3	00843	PUNTO-36 HL162 2X18W	2 x 18 W		5901477308437
4	00844	PUNTO-72 HL163 2X36W	2 x 36 W		5901477308444

220-240V-	G13	T8	20
	0,5		

**Materiał / Materiál / Material**

PL: tworzywo sztuczne

CZ: plast

SK: plast

**Uwagi / Komentář / Komentáre**

PL: balast elektroniczny (EVG) w komplecie

CZ: elektronický druh předradníku (EVG) součástí dodávky

SK: elektronický druh predradníka (EVG) súčasť dodávky



PL: Oprawa jest przystosowana do żarówek o klasach energetycznych:

CZ: Toto svítidlo je kompatibilní s žárovkami energetické třídy:

SK: Toto svetidlo je kompatibilné so žiarovkami energetických tried:





# FLAT LED

## Oświetleniowa oprawa liniowa SMD LED

cz: Svítidlo lineární SMD LED / sk: Svetidlo lineárne SMD LED



1 FLAT LED 10W 4000K



2 FLAT LED 20W 4000K



3 FLAT LED 30W 4000K



4 FLAT LED 40W 4000K

220-240V-	SMD LED		
4000K	140°	>80	30000h
IP 42		0,5	

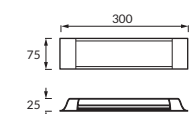

1 FLAT LED 10W 4000K

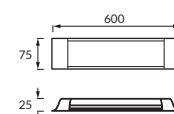

2 FLAT LED 20W 4000K

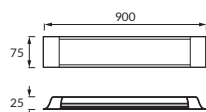

3 FLAT LED 30W 4000K

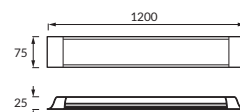

4 FLAT LED 40W 4000K

### Materiał / Materiál / Material

PL: tworzywo sztuczne, aluminium  
 cz: plast, hliník  
 sk: plast, hliník

### Uwagi / Komentár / Komentáre

PL: zasílacz w komplecie  
 cz: napájecí zdroj je součástí dodávky  
 sk: napájací zdroj je súčasťou dodávky

	01234						
1	02913	FLAT LED 10W 4000K	10 W	900 lm			5901477329135
2	02914	FLAT LED 20W 4000K	20 W	1800 lm	biały biłá	neutralna biła neutrálنی biłá	5901477329142
3	02915	FLAT LED 30W 4000K	30 W	2700 lm	biely	neutrálنی biela	5901477329159
4	02916	FLAT LED 40W 4000K	40 W	3600 lm			5901477329166



PL: W skład oprawy wchodzi wbudowane lampy LED  
 cz: Toto svítidlo obsahuje zabudované světelné zdroje LED  
 sk: Toto svetidlo obsahuje zabudované svetelné zdroje LED

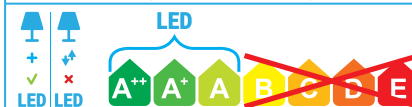

PL: Nie można wymieniać lamp w oprawie  
 cz: Světelné zdroje v tomto svítidle nelze vyměnit  
 sk: Svetelné zdroje v svetidle sa nedajú vymeniť

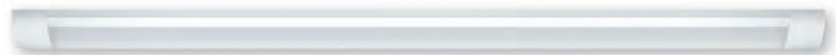

1 FLATER LED 10W 4000K

2 FLATER LED 20W 4000K

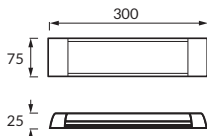

1 FLATER LED 10W 4000K

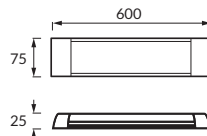

2 FLATER LED 20W 4000K

220-240V-	SMD LED	$\theta$	CRI
Tc 10 SMD46	140°	CRI >80	30000h
ON/OFF	IP 42		0,5

	01234	ABCDE					
1	03093	FLATER LED 10W 4000K	10 W	900 lm	biały biła biely	neutralna biała neutrální bílá neutrálna biela	5901477330933
2	03094	FLATER LED 20W 4000K	20 W	1800 lm			5901477330940

**Materiał / Materiál / Material**

PL: tworzywo sztuczne, aluminium

CZ: plast, hliník

SK: plast, hliník

**Uwagi / Komentář / Kommentäre**

PL: zasilacz w komplecie

CZ: napájecí zdroj je součástí dodávky

SK: napájací zdroj je súčasťou dodávky



PL: W skład oprawy wchodzi wbudowane lampy LED  
 CZ: Toto svítidlo obsahuje zabudované světelné zdroje LED  
 SK: Toto svetidlo obsahuje zabudované svetelné zdroje LED

LED

PL: Nie można wymieniać lamp w oprawie  
 CZ: Světelné zdroje v tomto svítidle nelze vyměnit  
 SK: Svetelné zdroje v svetidle sa nedajú vymeniť

# HL182L / GALAKSI / TURKUAZ HL56xL

## Panel LED

cz: Panel LED / sk: LED panel



1 HL182L 2700K



2 GALAKSI HL562L 32W WHITE 2700K



3 GALAKSI HL562L 32W WHITE 6400K



4 TURKUAZ HL564L 32W WHITE 2700K



5 TURKUAZ HL564L 32W WHITE 6400K

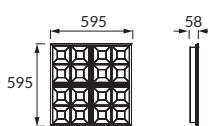
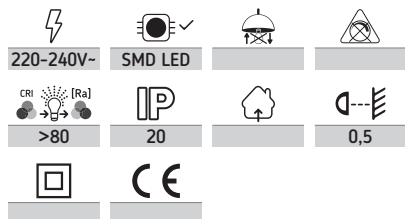

1 HL182L 2700K

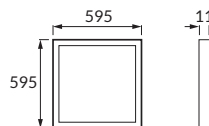

2 3 GALAKSI HL562L

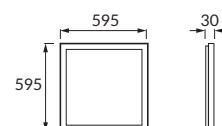

4 5 TURKUAZ HL564L

01234	ABCDE	40 W	3200 lm	32 W	1800 lm	2000 lm	1800 lm	2000 lm	2700K	6500K	90°	35000h	5901477326929
1	02692	HL182L 2700K											
2	02814	GALAKSI HL562L 32W WHITE 2700K											
3	02815	GALAKSI HL562L 32W WHITE 6400K											
4	02816	TURKUAZ HL564L 32W WHITE 2700K											
5	02817	TURKUAZ HL564L 32W WHITE 6400K											

**Materiał / Materiál / Material**  
 PL: blacha stalowa, tworzywo sztuczne  
 CZ: kovový výlisek, plast  
 SK: kovový výlisok, plast

**Uwagi / Komentář / Komentáre**  
 PL: zasilacz w komplecie  
 CZ: napájecí zdroj je součástí dodávky  
 SK: napájací zdroj je súčasťou dodávky



PL: W skład oprawy wchodzi wbudowane lampy LED  
 CZ: Toto svítidlo obsahuje zabudované světelné zdroje LED  
 SK: Toto svietidlo obsahuje zabudované svetelné zdroje LED

PL: Nie można wymieniać lamp w oprawie  
 CZ: Světelné zdroje v tomto svítidle nelze vyměnit  
 SK: Svetelné zdroje v svietidle sa nedajú vymeniť





1 HERMAN LED 18W



2 HERMAN LED 36W

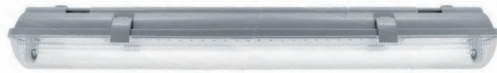

3 HERMAN LED 2x18W



4 HERMAN LED 2x36W

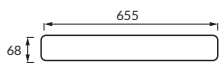

1 HERMAN LED 18W

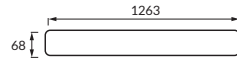

2 HERMAN LED 36W

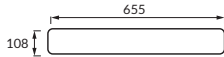

3 HERMAN LED 2x18W

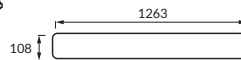

4 HERMAN LED 2x36W

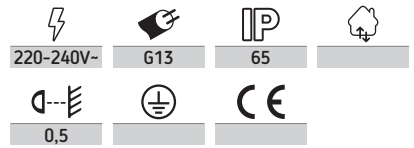

**Materiał / Materiál / Material**

PL: polistyren PS, ABS  
 CZ: polystyrenu PS, ABS  
 SK: polystyrénu PS, ABS

**Uwagi / Komentář / Komentáre**

PL: uchwyty do szybkiego montażu oraz dławnica w komplecie  
 CZ: úchyty pre rýchlu montáž sú súčasťou balenia  
 SK: úchyty pro rychlou montáž jsou součástí balení

Image	Code	Model	Power	Notes	Barcode	
	01234	ABCDE				
1	02926	HERMAN LED 18W	max 18 W	T8 LED zasílane jednostronnie T8 LED napájení z jedné strany T8 LED napájanie z jednej strany	5901477329265	
2	02927	HERMAN LED 36W	max 36 W		szary šedá šedá	5901477329272
3	02928	HERMAN LED 2x18W	2 x max 18 W		5901477329289	
4	02929	HERMAN LED 2x36W	2 x max 36 W		5901477329296	



PL: W skład oprawy wchodzi gniazda do lamp wymiennalnych LED.  
 CZ: Toto svítidlo obsahuje objímky pro výměnitelné LED zdroje.  
 SK: Toto svetidlo obsahuje objímky pre výmeniteľné LED zdroje.



# DAMLA HL14xL / TRONIC HL14x

## Oprawa pyłoszczelna

cz: Svítidlo prachotěsné / sk: Svetidlo prachotesné



1 DAMLA-20 HL141L 20W 6400K



2 DAMLA-40 HL142L 40W 6400K



3 TRONIC-1020 HL141 18W



4 TRONIC-1040 HL142 36W



5 TRONIC-2020 HL143 2X18W



6 TRONIC-2040 HL144 2X36W

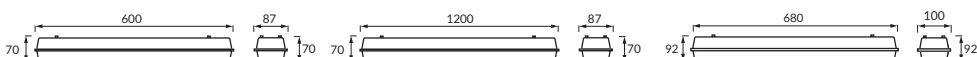

1 DAMLA-20 HL141L 20W 6400K

2 DAMLA-40 HL142L 40W 6400K

3 TRONIC-1020 HL141 18W

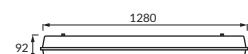

4 TRONIC-1040 HL142 36W

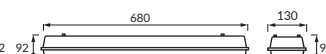

5 TRONIC-2020 HL143 2X18W

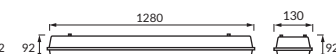

6 TRONIC-2040 HL144 2X36W

	01234	ABCDE														
1	02626	DAMLA-20 HL141L 20W 6400K	20 W	1868 lm	-	SMD LED	×	×		zimnobiata studená biela studená biela	6500K	35000h	80°	>80	65	5901477326264
2	02627	DAMLA-40 HL142L 40W 6400K	40 W	2654 lm		✓										5901477326271
3	01976	TRONIC-1020 HL141 18W	18 W													5901477319761
4	01978	TRONIC-1040 HL142 36W	36 W													5901477319785
5	01979	TRONIC-2020 HL143 2X18W	2 x 18 W		G13	T8	✓	-	szary šedá šedá						54	5901477319792
6	01980	TRONIC-2040 HL144 2X36W	2 x 36 W													5901477319808

### 1 2 DAMLA

#### Material / Materiál / Materiál

PL: poliwęglan PC, ABS  
cz: polycarbonát PC, ABS  
sk: polykarbonát PC, ABS

### 1 2 DAMLA

#### Uwagi / Komentář / Komentäre

PL: zasilacz w komplecie  
cz: napájecí zdroj je součástí dodávky  
sk: napájací zdroj je súčasťou dodávky

### 1 2 DAMLA

PL: W skład oprawy wchodzi wbudowane lampy LED  
cz: Toto svítidlo obsahuje zabudované světelné zdroje LED  
sk: Toto svetidlo obsahuje zabudované svetelné zdroje LED



PL: Nie można wymieniać lamp w oprawie  
cz: Světelné zdroje v tomto svítidle nelze vyměnit  
sk: Svetelné zdroje v svetidle sa nedajú vymeniť

### 3 5 6 TRONIC

#### Material / Materiál / Materiál

PL: polistyren PS  
cz: polystyrenu PS  
sk: polystyrénu PS

### 3 5 6 TRONIC

#### Uwagi / Komentář / Komentäre

PL: balast elektroniczny (EVG) w komplecie  
cz: elektronický druh předradníku (EVG) součástí dodávky  
sk: elektronický druh predradníku (EVG) súčasť dodávky

### 3 5 6 TRONIC

PL: Oprawa jest przystosowana do żarówek o klasach energetycznych:  
cz: Toto svítidlo je kompatibilní s žárovkami energetické třídy:  
sk: Toto svetidlo je kompatibilné so žiarovkami energetických tried:





1 MILANO-5 HL835L  
WHITE 4200K



2 MILANO-5 HL835L  
SILVER 4200K



3 MILANO-5 HL835L  
BLACK 4200K



7 MILANO-13 HL837L  
WHITE 4200K



9 MILANO-13 HL837L  
BLACK 4200K



4 MILANO-8 HL836L  
WHITE 4200K



5 MILANO-8 HL836L  
SILVER 4200K



6 MILANO-8 HL836L  
BLACK 4200K



8 MILANO-13 HL837L  
SILVER 4200K

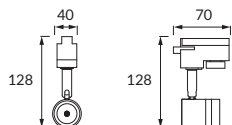

1 2 3 MILANO-5 HL835L

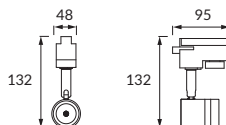

4 5 6 MILANO-8 HL836L

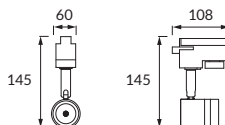

7 8 9 MILANO-13 HL837L

220-240V-	COB LED		
CRI >80	[Ra]	40000h	
IP 20		0,5	

01234	ABCDE							
1	02735	MILANO-5 HL835L WHITE 4200K	5 W	334 lm	biały / біла / біely	neutralna biała neutrální bílá neutrálna biela	55°	5901477327353
2	02719	MILANO-5 HL835L SILVER 4200K			srebrny / stříbrná / strieborná			5901477327193
3	02718	MILANO-5 HL835L BLACK 4200K			czarny / černá / čierna			5901477327186
4	02720	MILANO-8 HL836L WHITE 4200K	8 W	600 lm	biały / біла / біely		5901477327209	
5	02722	MILANO-8 HL836L SILVER 4200K			srebrny / stříbrná / strieborná		5901477327223	
6	02721	MILANO-8 HL836L BLACK 4200K			czarny / černá / čierna		5901477327216	
7	02736	MILANO-13 HL837L WHITE 4200K	13 W	987 lm	biały / біла / біely		5901477327360	
8	02724	MILANO-13 HL837L SILVER 4200K			srebrny / stříbrná / strieborná		5901477327247	
9	02723	MILANO-13 HL837L BLACK 4200K			czarny / černá / čierna		5901477327230	

PL: W skład oprawy wchodzi wbudowana lampa LED  
 CZ: Toto svítidlo obsahuje zabudovaný světelný zdroj LED  
 SK: Toto svetidlo obsahuje zabudovaný svetelný zdroj LED



PL: Nie można wymieniać lampy w oprawie  
 CZ: Světelný zdroj v tomto svítidle nelze vyměnit  
 SK: Svetelný zdroj v svetidle sa neda vymeniť



### Materiał / Materiál / Material

PL: odlew stopu aluminium, szkło  
 CZ: odlitek z hliníkové slitiny, sklo  
 SK: odliatok z hliníkovej zliatiny, sklo

### Uwagi / Komentář / Komentáre

PL: zasilacz w komplecie  
 CZ: napájecí zdroj je součástí dodávky  
 SK: napájací zdroj je súčasťou dodávky



# PRAG HL82xL / TORINO HL826L

Oprawa COB LED do szynoprzewodu

cz: Lištové svítidlo COB LED / sk: Lištové svietidlo COB LED



1 PRAG-7 HL823L  
WHITE 4200K



2 PRAG-7 HL823L  
SILVER 4200K



3 PRAG-7 HL823L  
BLACK 4200K



7 TORINO-23 HL826L  
WHITE 4200K



8 TORINO-23 HL826L  
SILVER 4200K



4 PRAG-12 HL824L  
WHITE 4200K



5 PRAG-12 HL824L  
SILVER 4200K



6 PRAG-12 HL824L  
BLACK 4200K



9 TORINO-23 HL826L  
BLACK 4200K

220-240V-	COB LED	45°	>80
SOCSM6	IP 20	4000K	0,5

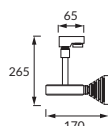

1 2 3 PRAG-7 HL823L

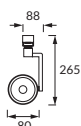

4 5 6 PRAG-12 HL824L

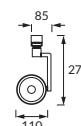
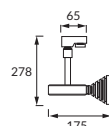

7 8 9 TORINO-23 HL826L

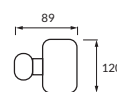
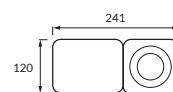

01234	ABCDE						
1	02427	PRAG-7 HL823L WHITE 4200K			biały / bílá / biely		
2	02429	PRAG-7 HL823L SILVER 4200K	7 W	405 lm	srebrny / stříbrná / strieborná		30000h
3	02428	PRAG-7 HL823L BLACK 4200K			czarny / černá / čierna		
4	02430	PRAG-12 HL824L WHITE 4200K			biały / bílá / biely		
5	02432	PRAG-12 HL824L SILVER 4200K	12 W	852 lm	srebrny / stříbrná / strieborná	neutralna biała neutrální bílá neutrálna biela	
6	02431	PRAG-12 HL824L BLACK 4200K			czarny / černá / čierna		
7	02686	TORINO-23 HL826L WHITE 4200K			biały / bílá / biely		40000h
8	02688	TORINO-23 HL826L SILVER 4200K	23 W	1560 lm	srebrny / stříbrná / strieborná		
9	02687	TORINO-23 HL826L BLACK 4200K			czarny / černá / čierna		

## Uwagi / Komentář / Komentáre

PL: zasilacz w komplecie

CZ: napájecí zdroj je součástí dodávky

SK: napájací zdroj je súčasťou dodávky

## 1 2 3 PRAG

### Materiál / Material / Materiál

PL: odlew stopu aluminium, szkło

CZ: odlitek z hliníkové slitiny, sklo

SK: odlitok z hliníkovej zliatiny, sklo

## 7 8 9 TORINO

### Materiál / Material / Materiál

PL: odlew stopu aluminium

CZ: odlitek z hliníkové slitiny

SK: odlitok z hliníkovej zliatiny

PL: W skład oprawy wchodzi wbudowana lampa LED

CZ: Toto svítidlo obsahuje zabudovaný světelný zdroj LED

SK: Toto svietidlo obsahuje zabudovaný svetelný zdroj LED



PL: Nie można wymienić lampy w oprawie

CZ: Světelný zdroj v tomto svítidle nelze vyměnit

SK: Svetelný zdroj v svietidle sa neda vymeniť

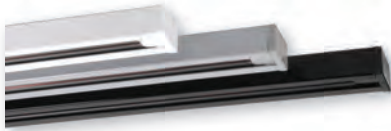

1 2 3 TRACK 1M



7 TRACK POINT WHITE



10 CONNECTOR I WHITE

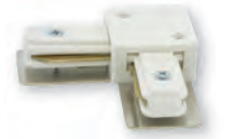

13 CONNECTOR L WHITE

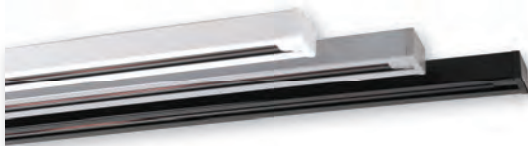

4 5 6 TRACK 2M

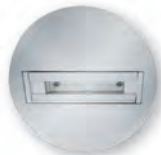

8 TRACK POINT SILVER



11 CONNECTOR I SILVER



14 CONNECTOR L SILVER



9 TRACK POINT BLACK



12 CONNECTOR I BLACK



15 CONNECTOR L BLACK

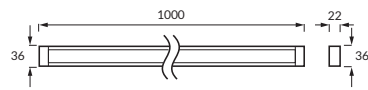

1 2 3 TRACK 1M

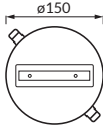

7 8 9 TRACK POINT

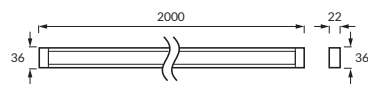

4 5 6 TRACK 2M

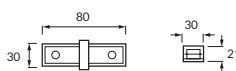

10 11 12 CONNECTOR I

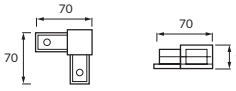

13 14 15 CONNECTOR L

220-240V-  
 IP 20

CE

1 ... 6 TRACK, 10 ... 15 CONNECTOR

**Materiał / Materiál / Material**

PL: aluminium, miedź, tworzywo sztuczne

CZ: hliník, měď, plast

SK: hliník, meď, plast

7 ... 9 TRACK POINT

**Materiał / Materiál / Material**

PL: blacha stalowa

CZ: kovový výlisek

SK: kovový výlisok

**Uwagi / Komentár / Komentáre**

PL: max 16 A

CZ: max 16 A

SK: max 16 A

	01234	ABCDE		
1	02436	TRACK 1M WHITE	biały / bílá / biely	5901477324369
2	02438	TRACK 1M SILVER	srebrny / stříbrná / strieborná	5901477324383
3	02437	TRACK 1M BLACK	czarny / černá / čierna	5901477324376
4	02439	TRACK 2M WHITE	biały / bílá / biely	5901477324390
5	02441	TRACK 2M SILVER	srebrny / stříbrná / strieborná	5901477324413
6	02440	TRACK 2M BLACK	czarny / černá / čierna	5901477324406
7	02702	TRACK POINT WHITE	biały / bílá / biely	5901477327025
8	02703	TRACK POINT SILVER	srebrny / stříbrná / strieborná	5901477327032
9	02704	TRACK POINT BLACK	czarny / černá / čierna	5901477327049
10	02515	CONNECTOR I WHITE	biały / bílá / biely	5901477325151
11	02517	CONNECTOR I SILVER	srebrny / stříbrná / strieborná	5901477325175
12	02516	CONNECTOR I BLACK	czarny / černá / čierna	5901477325168
13	02518	CONNECTOR L WHITE	biały / bílá / biely	5901477325182
14	02520	CONNECTOR L SILVER	srebrny / stříbrná / strieborná	5901477325205
15	02519	CONNECTOR L BLACK	czarny / černá / čierna	5901477325199

# URAL LED / TIBET LED

ideus

Plafoniera hermetyczna SMD LED

cz: Hermetické stropní svítidlo SMD LED / sk: Hermetické stropné svetidlo SMD LED



1 URAL LED WHITE



2 TIBET LED WHITE

220-240V-	12 W	SMD LED	900 lm
IP65	4000K	120°	>80
[Ra]	30000h	IP54	0,5

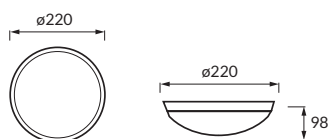

1 URAL LED WHITE

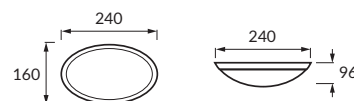

2 TIBET LED WHITE

## Materiał / Materiál / Material

PL: polipropylen, poliwęglan PC  
 CZ: polypropylen, polykarbonát PC  
 SK: polypropylén, polykarbonát PC

## Uwagi / Komentář / Komentáre

PL: zasilacz w komplecie  
 CZ: napájecí zdroj je součástí dodávky  
 SK: napájací zdroj je súčasťou dodávky

	01234	ABCDE			
1	02943	URAL LED WHITE	biały biłá biely	neutralna biłá neutrálنی biłá neutrálná biela	5901477329432
2	02944	TIBET LED WHITE			5901477329449



PL: W skład oprawy wchodzi wbudowane lampy LED  
 CZ: Toto svítidlo obsahuje zabudované světelné zdroje LED  
 SK: Toto svetidlo obsahuje zabudované svetelné zdroje LED



PL: Nie można wymieniać lamp w sprawie  
 CZ: Světelné zdroje v tomto svítidle nelze vyměnit  
 SK: Svetelné zdroje v svetidle sa nedajú vymeniť





1 AQUA ECO WHITE



3 AQUA OPAQUE WHITE



5 AQUA WALL FIXTURE WHITE



2 AQUA ECO BLACK



4 AQUA OPAQUE BLACK



6 AQUA WALL FIXTURE BLACK

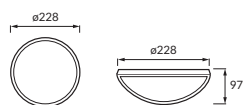

1 2 AQUA ECO

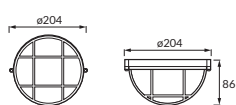

3 4 AQUA OPAQUE

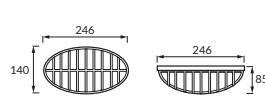

5 6 AQUA WALL FIXTURE

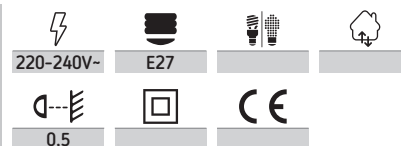

	01234	ABCDE			IP	
1	02259	AQUA ECO WHITE	max 60 W	biały / bílá / biely	65	5901477322594
2	02260	AQUA ECO BLACK		czarny / černá / čierna		5901477322600
3	02631	AQUA OPAQUE WHITE	max 15 W	biały / bílá / biely	65	5901477326318
4	02632	AQUA OPAQUE BLACK		czarny / černá / čierna		5901477326325
5	02371	AQUA WALL FIXTURE WHITE	max 26 W	biały / bílá / biely	54	5901477323713
6	02372	AQUA WALL FIXTURE BLACK		czarny / černá / čierna		5901477323720

Materiał / Materiál / Material
PL: polipropylen, poliwęglan PC
CZ: polypropylen, polykarbonát PC
SK: polypropylén, polykarbonát PC

PL: Oprawa jest przystosowana do żarówek o klasach energetycznych:  
 CZ: Toto svítidlo je kompatibilní s žárovkami energetické třídy:  
 SK: Toto svetidlo je kompatibilné so žiarovkami energetických tried:

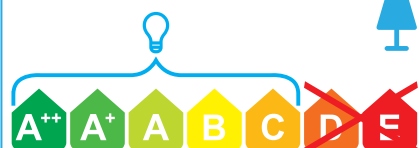

# AQUA DOLUNAY

ideus

Plafoniera hermetyczna

cz: Hermetické stropní svítidlo / sk: Hermetické stropné svetidlo



1 AQUA DOLUNAY WHITE



2 AQUA DOLUNAY BLACK

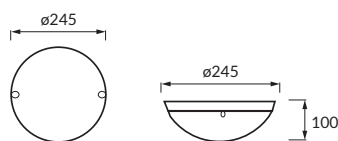
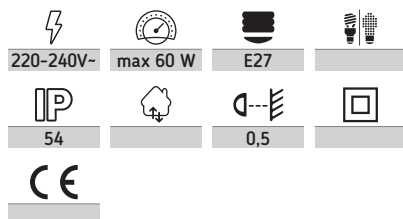

1 2 AQUA DOLUNAY

Materiał / Materiál / Material
PL: polipropylen, poliwęglan PC
CZ: polypropylen, polykarbonát PC
SK: polypropylén, polykarbonát PC

Uwagi / Komentář / Komentáre
PL: IK10
CZ: IK10
SK: IK10

01234	ABCDE		
1 02941	AQUA DOLUNAY WHITE	biały / bílá / biely	5901477329418
2 02548	AQUA DOLUNAY BLACK	czarny / černá / čierna	5901477325489



PL: Oprawa jest przystosowana do żarówek o klasach energetycznych:  
 cz: Toto svítidlo je kompatibilní s žárovkami energetické třídy:  
 sk: Toto svetidlo je kompatibilné so žiarovkami energetických tried:

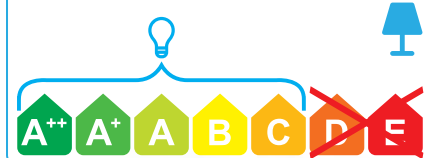



1 AQUA DOLUNAY WHITE S



2 AQUA DOLUNAY BLACK S

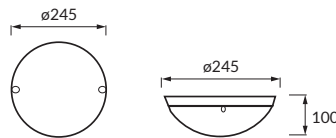

1 2 AQUA DOLUNAY S

220-240V~	max 60 W	E27	
MICRO	IP 54		0,5

	01234	ABCDE		
1	02942	AQUA DOLUNAY WHITE S	biały / bílá / biely	5901477329425
2	03076	AQUA DOLUNAY BLACK S	czarny / černá / čierna	5901477330766



PL: Oprawa jest przystosowana do żarówek o klasach energetycznych:  
 cz: Toto svítidlo je kompatibilní s žárovkami energetické třídy:  
 sk: Toto svietidlo je kompatibilné so žiarovkami energetických tried:

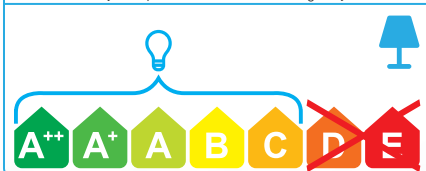

**Materiał / Material / Materiál**  
 PL: polipropylen, poliwęglan PC  
 cz: polypropylen, polycarbonát PC  
 sk: polypropylén, polykarbonát PC

**Uwagi / Komentář / Komentáre**  
 PL: kąt działania czujnika 360°  
 cz: rozsah čidla pohybu 360°  
 sk: uhol činnosti pohybového čidla 360°

**Uwagi / Komentář / Komentáre**  
 PL: regulacja czasu świecenia od 10s do 5min  
 cz: možnost regulace doby svícení od 10s do 5min  
 sk: možnosť regulácie doby svietenia od 10s do 5min

**Uwagi / Komentář / Komentáre**  
 możliwość ustawienia poziomu natężenia oświetlenia otoczenia (3-2000lx), przy którym urządzenie pracuje  
 cz: možnost nastavení úrovně osvětlení (3-2000lx), při němž zařízení pracuje  
 sk: možnosť nastavenia úrovne osvetlenia (3-2000lx), pri ktorom zariadenie pracuje

**Uwagi / Komentář / Komentáre**  
 PL: zasięg wykrywania ruchu max 8m (<24°C)  
 cz: maximální dosah čidla 8m (<24°C)  
 sk: maximálny dosah čidla 8m (<24°C)

**Uwagi / Komentář / Komentáre**  
 PL: IK10  
 cz: IK10  
 sk: IK10



## Plafoniera hermetyczna

*cz:* Hermetické stropní svítidlo / *sk:* Hermetické stropné svetidlo



1 FRYLIA HPD-323



2 FRYLIA HPD-324



3 DAVUS HPD-309

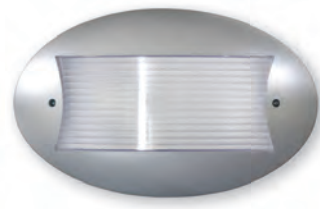

4 DAVUS HPD-311

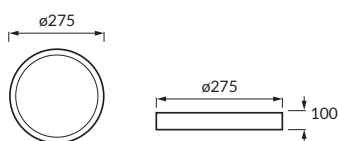
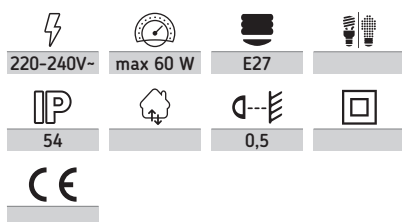

1 2 FRYLIA HPD

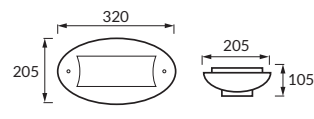

3 4 DAVUS HPD

### 1 2 FRYLIA HPD

#### Materiał / Materiál / Material

*PL:* poliwęglan PC, ABS

*CZ:* polykarbonát PC, ABS

*SK:* polykarbonát PC, ABS

### 3 4 DAVUS HPD

#### Materiał / Materiál / Material

*PL:* poliwęglan PC

*CZ:* polykarbonát PC

*SK:* polykarbonát PC

	01234	ABCDE		
1	00323	FRYLIA HPD-323	biały / białá / biely	5901477303234
2	00324	FRYLIA HPD-324	srebrny / stříbrná / strieborná	5901477303241
3	00309	DAVUS HPD-309	biały / białá / biely	5901477303098
4	00311	DAVUS HPD-311	srebrny / stříbrná / strieborná	5901477303111



*PL:* Oprawa jest przystosowana do żarówek o klasach energetycznych:

*CZ:* Toto svítidlo je kompatibilní s žárovkami energetické třídy:

*SK:* Toto svetidlo je kompatibilné so žiarovkami energetických tried:

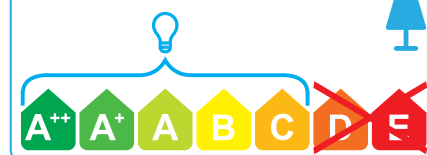



1 MONAT 100 WHITE



2 LOB 100 WHITE



3 WIR 75 WHITE

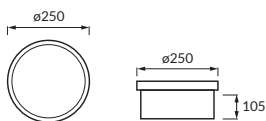

1 MONAT 100 WHITE

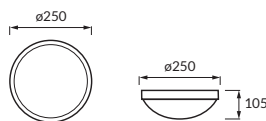

2 LOB 100 WHITE

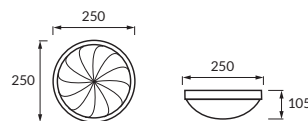

3 WIR 75 WHITE

	01234	ABCDE			
1	02393	MONAT 100 WHITE	max 100 W	biały biłá biely	5901477323935
2	02676	LOB 100 WHITE			5901477326769
3	02746	WIR 75 WHITE	max 75 W		5901477327469

220-240V~	E27		44
	0,5		

1 2 MONAT / LOB

**Materiał / Materiál / Materiál**

PL: polipropylen, szkło

CZ: polypropylen, sklo

SK: polypropylén, sklo

3 WIR 75 WHITE

**Materiał / Materiál / Materiál**

PL: polipropylen, poliwęglan PC

CZ: polypropylen, polykarbonát PC

SK: polypropylén, polykarbonát PC

3 WIR 75 WHITE

**Uwagi / Komentář / Komentáre**

PL: IK10

CZ: IK10

SK: IK10



PL: Oprawa jest przystosowana do żarówek o klasach energetycznych:

CZ: Toto svítidlo je kompatibilní s žárovkami energetické třídy:

SK: Toto svetidlo je kompatibilné so žiarovkami energetických tried:

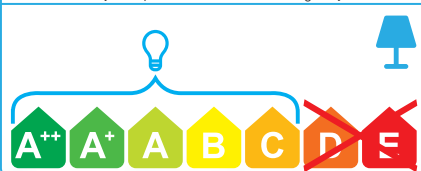



# ZIGANA / ALP / ARARAT / DORUK / EVEREST HL90x

## Plafoniera hermetyczna

cz: Hermetické stropné svietidlo / sk: Hermetické stropné svetidlo



1 2 ZIGANA HL905 WHITE/BLACK



3 4 ALP HL907 WHITE/BLACK



5 6 ARARAT HL906 WHITE/BLACK

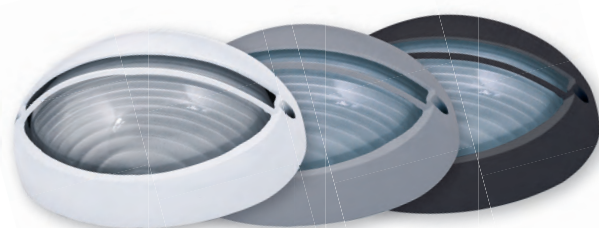

7 8 9 DORUK HL903 WHITE/GREY/BLACK



10 11 EVEREST HL908 WHITE/BLACK

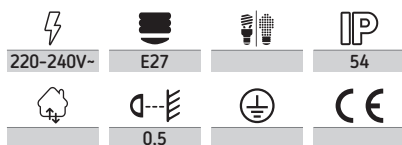

### Materiał / Materiál / Material

PL: aluminium, szkło

CZ: hliník, sklo

SK: hliník, sklo

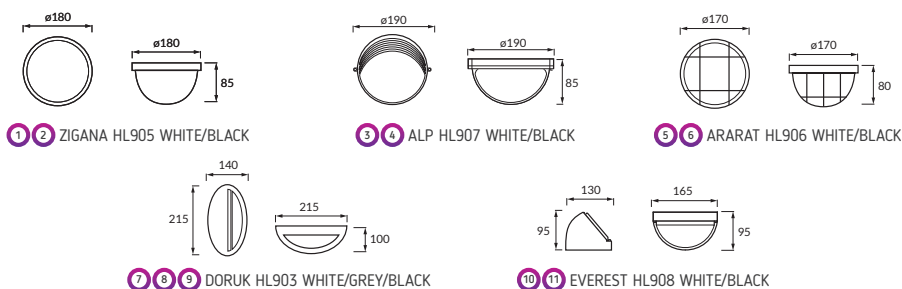
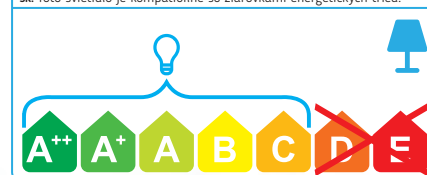

Image	Code	Model	Power	Color	Barcode
1	00479	ZIGANA HL905 WHITE	max 60 W	biały / bílá / biely	5901477304798
2	00480	ZIGANA HL905 BLACK		czarny / černá / čierna	5901477304804
3	00483	ALP HL907 WHITE	max 60 W	biały / bílá / biely	5901477304835
4	00484	ALP HL907 BLACK		czarny / černá / čierna	5901477304842
5	00481	ARARAT HL906 WHITE	max 60 W	biały / bílá / biely	5901477304811
6	00482	ARARAT HL906 BLACK		czarny / černá / čierna	5901477304828
7	00474	DORUK HL903 WHITE	max 60 W	biały / bílá / biely	5901477304743
8	00476	DORUK HL903 GREY		szary / šedá / šedá	5901477304767
9	00475	DORUK HL903 BLACK		czarny / černá / čierna	5901477304750
10	00485	EVEREST HL908 WHITE	max 40 W	biały / bílá / biely	5901477304859
11	00486	EVEREST HL908 BLACK		czarny / černá / čierna	5901477304866

PL: Oprawa jest przystosowana do żarówek o klasach energetycznych:

CZ: Toto svietidlo je kompatibilné s žiarovkami energetickej triedy:

SK: Toto svetidlo je kompatibilné so žiarovkami energetickej triedy:







1 REX 60 WHITE



2 ERAST HPD-320



4 EBEN 60 WHITE



3 EBEN LED WHITE



5 EBEN 60 GREY PRO

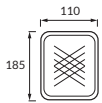

1 REX



2 ERAST

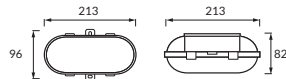

3 4 5 EBEN

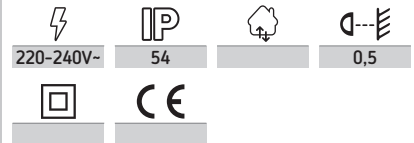

1	01234	ABCDE														
1	02748	REX 60 WHITE	max 60 W		biały biła biely										5901477327483	
2	00320	ERAST HPD-320	max 18 W		szary šedá šedá		E27		✓	-	-	-	-	-	5901477303203	
3	02749	EBEN LED WHITE	5 W	660 lm	biały biła biely	neutralna biła neutrální biła neutrálna biela		SMD LED	✓	×	×	4000K	55°	>80	30000h	5901477327490
4	02391	EBEN 60 WHITE	max 60 W		szary šedá šedá											5901477323911
5	02392	EBEN 60 GREY PRO	max 60 W		szary šedá šedá		E27		✓	-	-	-	-	-	-	5901477323928

1 2 4 5 REX / ERAST / EBEN 60

PL: Oprawa jest przystosowana do żarówek o klasach energetycznych:  
 CZ: Toto svítidlo je kompatibilní s žárovkami energetické třídy:  
 SK: Toto svetidlo je kompatibilné so žiarovkami energetických tried.

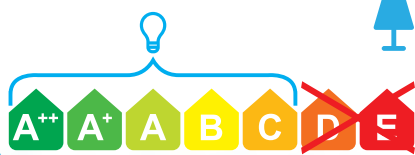

3 EBEN LED

PL: W skład oprawy wchodzi wbudowane lampy LED  
 CZ: Toto svítidlo obsahuje zabudované světelné zdroje LED  
 SK: Toto svetidlo obsahuje zabudované svetelné zdroje LED



PL: Nie można wymieniać lamp w oprawie  
 CZ: Světelné zdroje v tomto svítidle nelze vyměnit  
 SK: Svetelné zdroje v svetidle sa nedajú vymeniť

1 REX 60 WHITE

Material / Materiál / Material

PL: bakelit, poliwęglan PC  
 CZ: bakelite, polykarbonát PC  
 SK: bakelite, polykarbonát PC

3 4 EBEN LED WHITE / EBEN 60 WHITE

Uwagi / Komentář / Komentáře

PL: polipropylen, szkło  
 CZ: polypropylen, sklo  
 SK: polypropylén, sklo

2 ERAST HPD-320

Uwagi / Komentář / Komentáře

PL: poliwęglan PC  
 CZ: polykarbonát PC  
 SK: polykarbonát PC

5 EBEN 60 GREY PRO

Uwagi / Komentář / Komentáře

PL: polipropylen, szkło, stal  
 CZ: polypropylen, sklo, ocel  
 SK: polypropylén, sklo, ocel

# MANGO HL23x

Plafoniera hermetyczna

*cz:* Hermetické stropní svítidlo / *sk:* Hermetické stropné svetidlo



① MANGO-1 HL237 15W

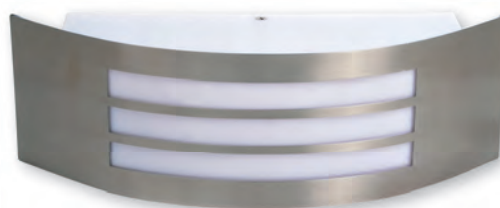

② MANGO-2 HL238 15W

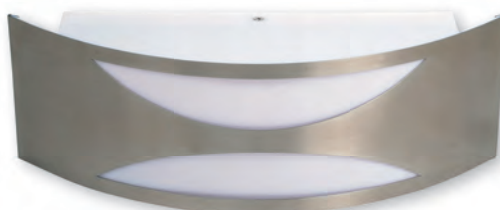

③ MANGO-3 HL239 15W

220-240V-	max 15 W	E27	
IP 44		0,5	

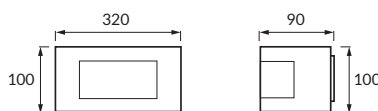

① ② ③ MANGO

Materiał / Materiál / Materiál
<i>PL:</i> stal nierdzewna, poliwęglan PC
<i>CZ:</i> nerezová ocel, polykarbonát PC
<i>SK:</i> nerezová ocel, polykarbonát PC

	01234	ABCDE		
1	01146	MANGO-1 HL237 15W	matowy chrom	5901477311468
2	01147	MANGO-2 HL238 15W	matný chrom	5901477311475
3	01148	MANGO-3 HL239 15W	matný chróm	5901477311482



*PL:* Oprawa jest przystosowana do żarówek o klasach energetycznych:  
*CZ:* Toto svítidlo je kompatibilní s žárovkami energetické třídy:  
*SK:* Toto svetidlo je kompatibilné so žiarovkami energetických tried:

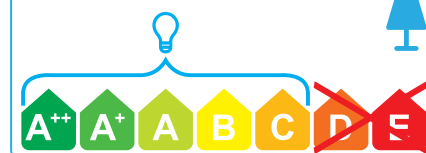



1 GRETA E27 DARK GREY

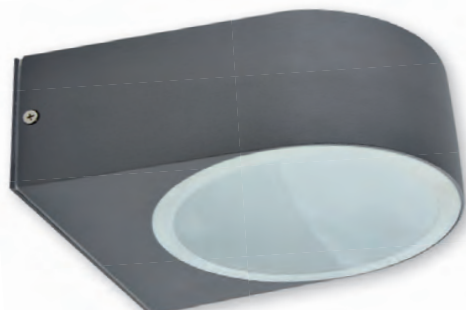

2 LIMO E27 DARK GREY

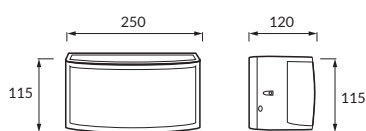

1 GRETA E27 DARK GREY

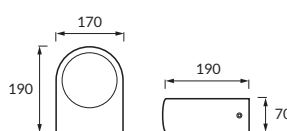

2 LIMO E27 DARK GREY

220-240V-	E27		IP 54
	0,5		

**Materiał / Materiál / Material**

PL: odlew stopu aluminium, poliwęglan PC  
 cz: odlitek z hliníkové slitiny, polykarbonát PC  
 sk: odliatok z hliníkovej zliatiny, polykarbonát PC

	01234	ABCDE			
1	03019	GRETA E27 DARK GREY	max 40 W	ciemny szary / tmavošedá / tmavošedý	5901477330193
2	03133	LIMO E27 DARK GREY	max 60 W		5901477331336



PL: Oprawa jest przystosowana do żarówek o klasach energetycznych:  
 cz: Toto svítidlo je kompatibilní s žárovkami energetické třídy:  
 sk: Toto svietidlo je kompatibilné so žiarovkami energetických tried.

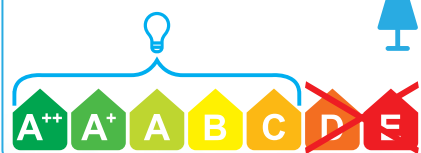



# ASTER / MANOLYA HL26x

ideus

Oprawa hermetyczna

CZ: Prachotěsné svítidlo / SK: Prachotesné svietidlo



1 ASTER  
GU10 INOX

2 ASTER  
2xGU10 INOX

3 MANOLYA-1  
HL265 35W

4 MANOLYA-2  
HL266 2X35W

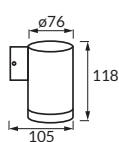
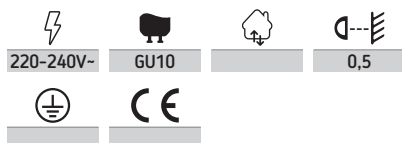

1 ASTER  
GU10 INOX

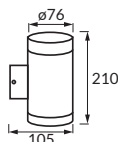

2 ASTER  
2xGU10 INOX

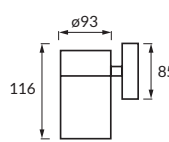

3 MANOLYA-1  
HL265 35W

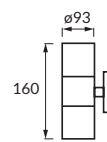

4 MANOLYA-2  
HL266 2X35W

	01234	ABCDE							IP	
1	03015	ASTER GU10 INOX	max 35 W	-	matowy chrom matný chrom matný chróm	GU10	-	-	54	5901477330155
2	03016	ASTER 2xGU10 INOX	2 x max 35 W	-		GU10	-	-	54	5901477330162
3	01177	MANOLYA-1 HL265 35W	max 35 W	500 lm	matný chróm	GU10	45°	1500h	44	5901477311772
4	01178	MANOLYA-2 HL266 2X35W	2 x max 35 W	2 x 500 lm		GU10			44	5901477311789

**Materiał / Materiál / Materiál**

PL: stal nierdzewna, szkło

CZ: nerezová ocel, sklo

SK: nerezová ocel, sklo



1 2 ASTER

PL: Oprawa jest przystosowana do żarówek o klasach energetycznych:  
CZ: Toto svítidlo je kompatibilní s žárovkami energetické třídy:  
SK: Toto svietidlo je kompatibilné so žiarovkami energetických tried:

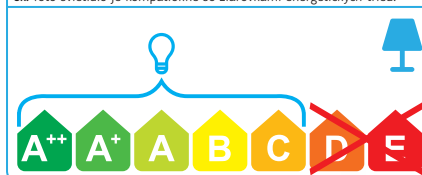

3 4 MANOLYA

PL: Oprawa jest przystosowana do żarówek o klasach energetycznych:  
CZ: Toto svítidlo je kompatibilní s žárovkami energetické třídy:  
SK: Toto svietidlo je kompatibilné so žiarovkami energetických tried:

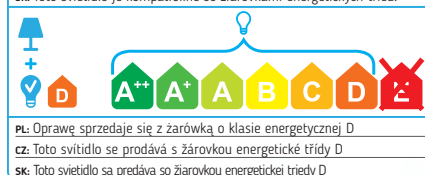



1 KELER GU10 INOX    2 KELER 2xGU10 INOX    3 GARDENYA-1 HL246 35W    4 GARDENYA-2 HL247 2X35W    5 GARDENYA-3 HL248 35W    6 GARDENYA-4 HL249 2X35W

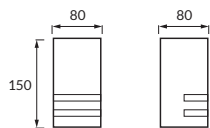

1 KELER GU10 INOX

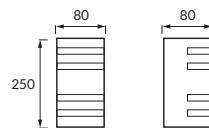

2 KELER 2xGU10 INOX

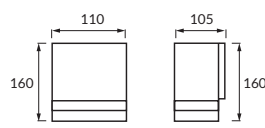

3 GARDENYA-1 HL246 35W

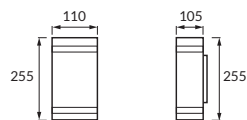

4 GARDENYA-2 HL247 2X35W

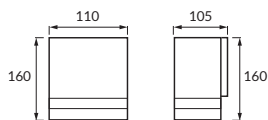

5 GARDENYA-3 HL248 35W

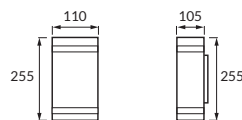

6 GARDENYA-4 HL249 2X35W



1	01234	ABCDE								
1	03017	KELER GU10 INOX	max 35 W	-	matowy chrom matný chrom matný chróm	GU10	-	-	54	5901477330179
2	03018	KELER 2xGU10 INOX	2 x max 35 W	-						5901477330186
3	01158	GARDENYA-1 HL246 35W	max 35 W	500 lm	matowy chrom matný chrom matný chróm	GU10	45°	1500h	44	5901477311581
4	01159	GARDENYA-2 HL247 2X35W	2 x max 35 W	2 x 500 lm						5901477311598
5	01161	GARDENYA-3 HL248 35W	max 35 W	500 lm						5901477311611
6	01162	GARDENYA-4 HL249 2X35W	2 x max 35 W	2 x 500 lm						5901477311628

1 2 KELER

**Materiał / Materiál / Material**

PL: odlew stopu aluminium, szkło  
 cz: odlitek z hliníkové slitiny, sklo  
 sk: odliatok z hliníkovej zliatiny, sklo

3 4 5 6 GARDENYA

**Materiał / Materiál / Material**

PL: stal nierdzewna, poliwęglan PC  
 cz: nerezová ocel, polykarbonát PC  
 sk: nerezová ocel, polykarbonát PC

1 2 KELER

PL: Oprawa jest przystosowana do żarówek o klasach energetycznych:  
 cz: Toto svítidlo je kompatibilní s žárovkami energetické třídy:  
 sk: Toto svetidlo je kompatibilné so žiarovkami energetických tried:

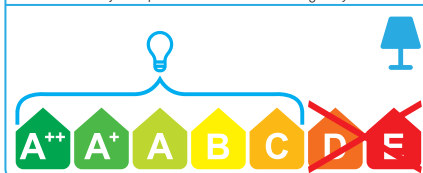

3 4 5 6 GARDENYA

PL: Oprawa jest przystosowana do żarówek o klasach energetycznych:  
 cz: Toto svítidlo je kompatibilní s žárovkami energetické třídy:  
 sk: Toto svetidlo je kompatibilné so žiarovkami energetických tried:



# FOREST

Oprawa hermetyczna

CZ: Prachotěsné svítidlo / SK: Prachotesné svietidlo



1 FOREST  
GU10 C

2 FOREST  
2xGU10 C

3 FOREST  
GU10 D

4 FOREST  
2xGU10 D

220-240V-	GU10	GU10	IP 54
0,5			

**Materiał / Materiál / Material**  
 PL: odlew stopu aluminium, szkło  
 CZ: odlitek z hliníkové slitiny, sklo  
 SK: odliatok z hliníkovej zliatiny, sklo

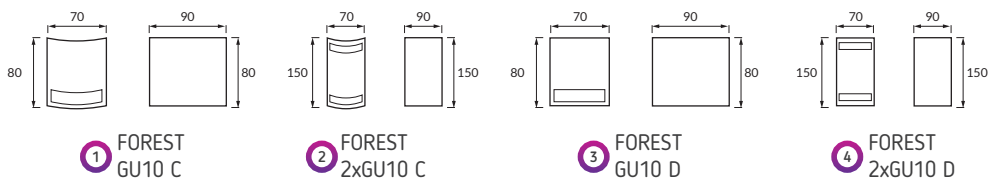

	01234	ABCDE			
1	03011	FOREST GU10 C	max 35 W	grafitowy grafit grafit	5901477330117
2	03012	FOREST 2xGU10 C	2 x max 35 W		5901477330124
3	03013	FOREST GU10 D	max 35 W		5901477330131
4	03014	FOREST 2xGU10 D	2 x max 35 W		5901477330148



PL: Oprawa jest przystosowana do żarówek o klasach energetycznych:  
 CZ: Toto svítidlo je kompatibilní s žárovkami energetické třídy:  
 SK: Toto svietidlo je kompatibilné so žiarovkami energetických tried:

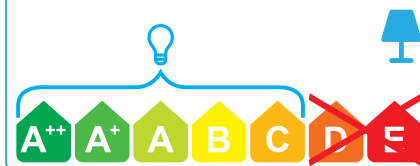





1 TARO LED 2x5W C



2 TARO LED 2x5W D

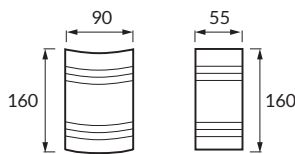

1 TARO LED 2x5W C

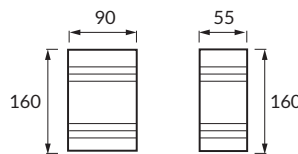

2 TARO LED 2x5W D

1	03020	TARO LED 2x5W C	ciemny szary tmavošedá tmavošedý	neutralna biała neutrální bílá neutrálna biela	5901477330209
2	03021	TARO LED 2x5W D			5901477330216

220-240V-	2 x 5 W	POWER LED	840 lm
90°	>70	4000K	90°
IP54	30000h	IP54	
0,5			

**Materiał / Materiál / Materiál**

PL: odlew stopu aluminium, szkło

CZ: odlitek z hliníkové slitiny, sklo

SK: odliatok z hliníkovej zliatiny, sklo

**Uwagi / Komentář / Komentáre**

PL: zasílacz w komplecie

CZ: napájecí zdroj je součástí dodávky

SK: napájací zdroj je súčasťou dodávky



PL: W skład oprawy wchodzi wbudowane lampy LED  
 CZ: Toto svítidlo obsahuje zabudované světelné zdroje LED  
 SK: Toto svetidlo obsahuje zabudované svetelné zdroje LED

**LED**

LED LED A++ A+ A B C D E

PL: Nie można wymieniać lamp w oprawie  
 CZ: Světelné zdroje v tomto svítidle nelze vyměnit  
 SK: Svetelné zdroje v svetidle sa nedajú vymeniť

# ARDIC / MESE / TAFLAN / SELVI / SALKIM

## Oprawa hermetyczna

CZ: Prachotěsné svítidlo / SK: Prachotesné svietidlo



1 ARDIC HL237L  
BLACK 4100K

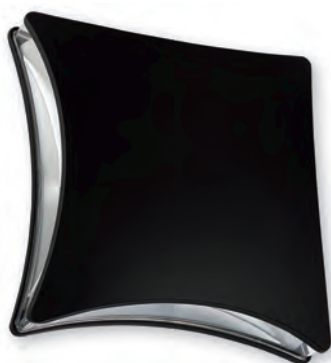

3 TAFLAN HL240L  
BLACK 4100K



4 SELVI HL241L  
BLACK 4100K



5 SALKIM HL242L  
BLACK 4100K



2 MESE HL238L  
BLACK 4100K

220-240V~			4000K
>80	30000h	IP44	
0,5			

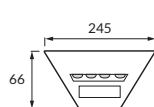

1 ARDIC HL237L BLACK 4100K

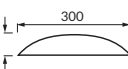
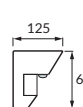

2 MESE HL238L BLACK 4100K

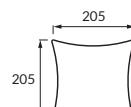
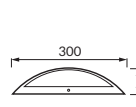

3 TAFLAN HL240L BLACK 4100K

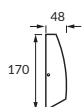
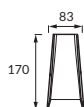

4 SELVI HL241L BLACK 4100K

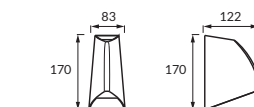

5 SALKIM HL242L BLACK 4100K

1	02635	ARDIC HL237L BLACK 4100K	5,5 W	385 lm	czarny czarna čierna	neutralna biała neutrální bílá neutrálna biela	4 POWER LED	45°	5901477326356
2	02636	MESE HL238L BLACK 4100K		420 lm					5901477326363
3	02694	TAFLAN HL240L BLACK 4100K		200 lm					5901477326943
4	02695	SELVI HL241L BLACK 4100K	3,5 W	35 lm		SMD LED	35°	5901477326950	
5	02696	SALKIM HL242L BLACK 4100K		65 lm				5901477326967	

### Materiał / Materiál / Material

PL: odlew stopu aluminium, szkło  
CZ: odlitek z hliníkové slitiny, sklo  
SK: odliatok z hliníkovej zliatiny, sklo

### Uwagi / Komentář / Kommentäre

PL: zasilacz w komplecie  
CZ: napájecí zdroj je součástí dodávky  
SK: napájací zdroj je súčasťou dodávky



PL: W skład oprawy wchodzi wbudowane lampy LED  
CZ: Toto svítidlo obsahuje zabudované světelné zdroje LED  
SK: Toto svietidlo obsahuje zabudované svetelné zdroje LED



PL: Nie można wymieniać lamp w oprawie  
CZ: Světelné zdroje v tomto svítidle nelze vyměnit  
SK: Svetelné zdroje v svietidle sa nedajú vymeniť





1 PALMIYE-1 HL295 100W



2 PALMIYE-2 HL296 100W



3 PALMIYE-3 HL297 100W



4 PALMIYE-4 HL298 100W

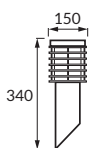

1 PALMIYE-1  
HL295 100W

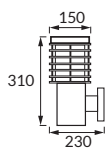

2 PALMIYE-2  
HL296 100W

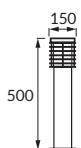

3 PALMIYE-3  
HL297 100W

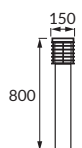

4 PALMIYE-4  
HL298 100W

220-240V~	max 100 W	E27	
IP 44		0,5	

CE

	01234	ABCDE		
1	01203	PALMIYE-1 HL295 100W	czarny černá čierna	5901477312038
2	01204	PALMIYE-2 HL296 100W		5901477312045
3	01205	PALMIYE-3 HL297 100W		5901477312052
4	01206	PALMIYE-4 HL298 100W		5901477312069

**Materiał / Materiál / Materiál**

- PL: stal nierdzewna, poliwęglan PC
- cz: nerezová ocel, polykarbonát PC
- sk: nerezová ocel, polykarbonát PC



PL: Oprawa jest przystosowana do żarówek o klasach energetycznych:  
 cz: Toto svítidlo je kompatibilní s žárovkami energetické třídy:  
 sk: Toto svetidlo je kompatibilné so žiarovkami energetických tried:

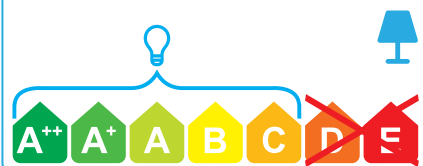





1 WELMA BLACK-60



2 WELMA BLACK-80



3 WELMA BLACK-100

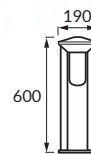

1 WELMA BLACK-60

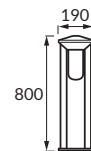

2 WELMA BLACK-80

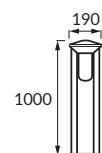

3 WELMA BLACK-100

220-240V-	max 60 W	E27	
44		0,5	

CE

Materiał / Materiál / Material
PL: poliwęglan PC, aluminium
CZ: polykarbonát PC, hliník
SK: polykarbonát PC, hliník

01234	ABCDE		
1	00393	WELMA BLACK-60	
2	00394	WELMA BLACK-80	
3	00395	WELMA BLACK-100	
		czarny černá čierna	
			5901477303937
			5901477303944
			5901477303951



PL: Oprawa jest przystosowana do żarówek o klasach energetycznych:  
 cz: Toto svítidlo je kompatibilní s žárovkami energetické třídy:  
 sk: Toto svetidlo je kompatibilné so žiarovkami energetických tried:

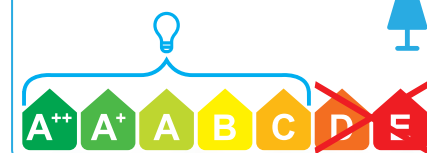



1 BEGONYA2 WHITE



2 BEGONYA2 BLACK



3 BEGONYA1 WHITE



4 BEGONYA1 BLACK

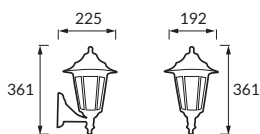

1 2 BEGONYA2

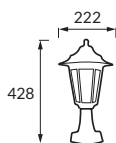

3 4 BEGONYA1

220-240V-	max 40 W	E27	
IP 44		0,5	

	01234	ABCDE		
1	03080	BEGONYA2 WHITE	biały / białá / biely	5901477330803
2	03081	BEGONYA2 BLACK	czarny / černá / čierna	5901477330810
3	03078	BEGONYA1 WHITE	biały / białá / biely	5901477330780
4	03079	BEGONYA1 BLACK	czarny / černá / čierna	5901477330797

Materiał / Materiál / Material

PL: polipropylen, poliwęglan PC  
 cz: polypropylen, polycarbonát PC  
 sk: polypropylén, polykarbonát PC



PL: Oprawa jest przystosowana do żarówek o klasach energetycznych:  
 cz: Toto svítidlo je kompatibilní s žárovkami energetické třídy:  
 sk: Toto svetidlo je kompatibilné so žiarovkami energetických tried:

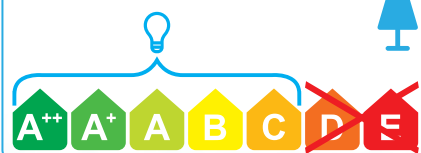



# PLANT LED / SAFRAN HL281L

ideus

Wodoszczelna oprawa

cz: Vodotěsné svítidlo / sk: Vodotěsné svítidlo



1 PLANT LED 3W  
BLACK 4500K



2 PLANT LED 5W  
BLACK 4500K



3 SAFRAN-5  
HL281L WHITE



4 SAFRAN-5  
HL281L BLACK

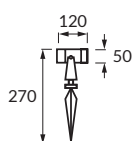
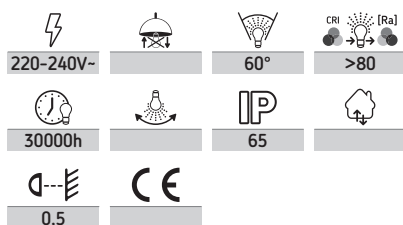

1 PLANT LED 3W

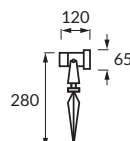

2 PLANT LED 5W

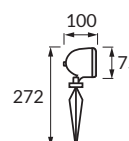

3 4 SAFRAN-5 HL281L

01234	ABCDE								
1	03129	PLANT LED 3W BLACK 4500K	3 W	180 lm	czarny / černá / čierna	neutralna biela neutrální bílá neutrálna biela	COB LED	4500K	5901477331299
2	03130	PLANT LED 5W BLACK 4500K		350 lm					
3	02742	SAFRAN-5 HL281L WHITE	5 W	409 lm	biały / bílá / biely	zimnobiała studená bílá studená biela	15 SMD LED	6500K	5901477327421
4	02741	SAFRAN-5 HL281L BLACK			czarny / černá / čierna				5901477327414

## 1 2 PLANT

### Materiał / Materiál / Material

PL: odlew stopu aluminium

CZ: odlitek z hliníkové slitiny

SK: odliatok z hliníkovej zliatiny

## 3 4 SAFRAN-5 HL281L

### Materiał / Materiál / Material

PL: tworzywo sztuczne

CZ: plast

SK: plast

### Uwagi / Komentář / Kommentäre

PL: zasilacz w komplecie

CZ: napájecí zdroj je součástí dodávky

SK: napájací zdroj je súčasťou dodávky



PL: W skład oprawy wchodzi wbudowane lampy LED  
CZ: Toto svítidlo obsahuje zabudované světelné zdroje LED  
SK: Toto svietidlo obsahuje zabudované svetelné zdroje LED

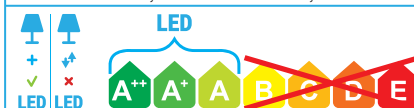

PL: Nie można wymieniać lamp w oprawie  
CZ: Světelné zdroje v tomto svítidle nelze vyměnit  
SK: Svetelné zdroje v svietidle sa nedajú vymeniť





1 HALLEY  
LED 0,06W 6500K



2 MAGIC  
LED 0,54W 6500K



3 WIZARD  
SOLARO LED 2W 6500K

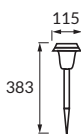

1 HALLEY  
LED 0,06W 6500K

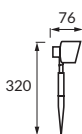

2 MAGIC  
LED 0,54W 6500K

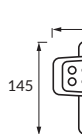
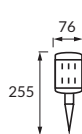

3 WIZARD  
SOLARO LED 2W 6500K

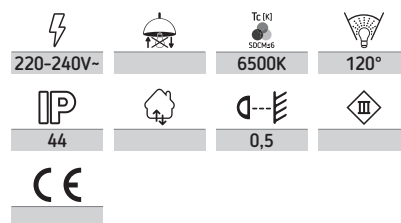
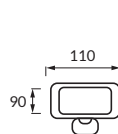

	01234	ABCDE											
1	02965	HALLEY LED 0,06W 6500K	Ni-MH AA 100 mAh 1.2 V	0,06 W	1,5 lm	chrom chrom chrom							5901477329654
2	02963	MAGIC LED 0,54W 6500K	3 Ni-MH 100 mAh 1.2 V	0,54 W	9 x 1,5 lm	czarny czarna czarna	zimmnobiała studeną biłą studeną biela	LED	×	>70	100000h	×	5901477329630
3	02848	WIZARD SOLARO LED 2W 6500K	3 Ni-MH 600 mAh 1.2 V	2 W	150 lm			10 SMD LED		>80	50000h	✓	5901477328480

1 2 HALLEY / MAGIC LED

⚠ Uwagi / Komentarz / Komentarze

PL: akumulator w komplecie  
CZ: baterie součástí dodávky  
SK: batéria súčasťou dodávky

1 2 HALLEY / MAGIC LED

⚠ Uwagi / Komentarz / Komentarze

PL: czas świecenia dla jednego ładowania min 6 h  
CZ: doba svícení na jedno nabití min 6 h  
SK: doba svietenia na jedno nabitie min 6 h

3 WIZARD SOLARO LED

⚠ Uwagi / Komentarz / Komentarze

PL: kąt działania czujnika 90°  
CZ: rozsah čidla pohybu 90°  
SK: uhol činnosti pohybového čidla 90°

3 WIZARD SOLARO LED

⚠ Uwagi / Komentarz / Komentarze

PL: zasięg wykrywania ruchu max 10m (<24°C)  
CZ: maximální dosah čidla 10m (<24°C)  
SK: maximálny dosah čidla 10m (<24°C)

1 HALLEY

🔍 Materiał / Materiál / Material

PL: blacha stalowa, tworzywo sztuczne  
CZ: kovový výlisek, plast  
SK: kovový výlisok, plast

2 3 MAGIC LED / WIZARD SOLARO LED

🔍 Materiał / Materiál / Material

PL: tworzywo sztuczne  
CZ: plast  
SK: plast

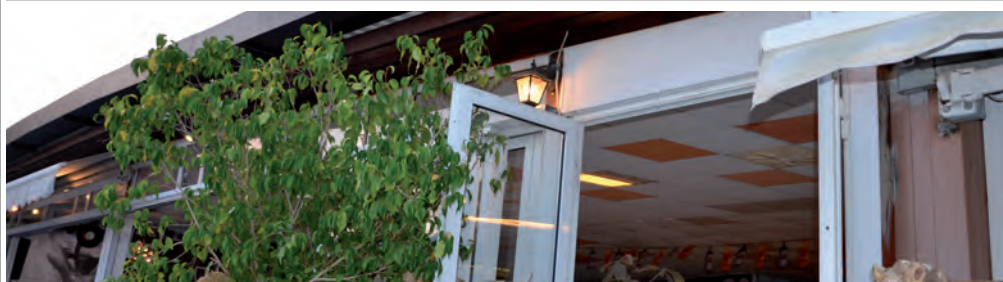

# OLIMP LED / OLIMP LED S

## Naświetlacz SMD LED

cz: Světlomet SMD LED / sk: Svetlomet SMD LED



1 OLIMP LED 10W  
BLACK 4500K



2 OLIMP LED 20W  
BLACK 4500K



3 OLIMP LED 30W  
BLACK 4500K



4 OLIMP LED 50W  
BLACK 4500K



5 OLIMP LED 100W  
BLACK 4500K



6 OLIMP LED S 10W  
BLACK 4500K



7 OLIMP LED S 20W  
BLACK 4500K



8 OLIMP LED S 30W  
BLACK 4500K



9 OLIMP LED S 50W  
BLACK 4500K

220-240V~	SMD LED	IP65	4500K
120°	>70	[Ra]	30000h
	0,5		

1 OLIMP LED 10W BLACK 4500K	2 OLIMP LED 20W BLACK 4500K	3 OLIMP LED 30W BLACK 4500K	4 OLIMP LED 50W BLACK 4500K	5 OLIMP LED 100W BLACK 4500K
6 OLIMP LED S 10W BLACK 4500K	7 OLIMP LED S 20W BLACK 4500K	8 OLIMP LED S 30W BLACK 4500K	9 OLIMP LED S 50W BLACK 4500K	

**Materiał / Materiál / Material**  
 PL: aluminium, szkło  
 cz: hliník, sklo  
 sk: hliník, sklo

**Uwagi / Komentář / Komentáre**  
 PL: zasilacz w komplecie  
 cz: napájecí zdroj je součástí dodávky  
 sk: napájací zdroj je súčasťou dodávky

6...9 OLIMP LED S

**Uwagi / Komentář / Komentáre**  
 PL: zasięg wykrywania ruchu max 12m (<24°C)  
 cz: maximální dosah čidla 12m (<24°C)  
 sk: maximálny dosah čidla 12m (<24°C)

6...9 OLIMP LED S

**Uwagi / Komentář / Komentáre**  
 PL: regulacja czasu świecenia od 12s do 6min  
 cz: možnost regulace doby svícení od 12s do 6min  
 sk: možnost regulácie doby svietenia od 12s do 6min

6...9 OLIMP LED S

**Uwagi / Komentář / Komentáre**  
 PL: regulacja położenia czujnika ruchu 180°/160° (V/H)  
 cz: regulácia pozície pohybového senzora 180°/160° (V/H)  
 sk: regulácie pozície pohybového čidla 180°/160° (V/H)

1	02820	OLIMP LED 10W BLACK 4500K	10 W	850 lm	czarna czarna czarna	neutralna biała neutralni biała neutralna biała	X	65	5901477328206
2	02821	OLIMP LED 20W BLACK 4500K	20 W	1750 lm					5901477328213
3	02822	OLIMP LED 30W BLACK 4500K	30 W	2600 lm					5901477328220
4	02823	OLIMP LED 50W BLACK 4500K	50 W	4400 lm					5901477328237
5	02930	OLIMP LED 100W BLACK 4500K	100 W	8700 lm					5901477329302
6	02824	OLIMP LED S 10W BLACK 4500K	10 W	850 lm	✓ PIR		44	5901477328244	
7	02825	OLIMP LED S 20W BLACK 4500K	20 W	1750 lm				5901477328251	
8	02826	OLIMP LED S 30W BLACK 4500K	30 W	2600 lm				5901477328268	
9	02827	OLIMP LED S 50W BLACK 4500K	50 W	4400 lm				5901477328275	

6...9 OLIMP LED S

**Uwagi / Komentář / Komentáre**  
 PL: możliwość ustawienia poziomu natężenia oświetlenia otoczenia (10-2000lx)  
 cz: možnost nastavení úrovně osvětlení (10-2000lx), při němž zařízení pracuje  
 sk: možnost nastavenia úrovne osvetlenia (10-2000lx), pri ktorom zariadenie pracuje

6...9 OLIMP LED S

**Uwagi / Komentář / Komentáre**  
 PL: kąt wykrywania ruchu 30°/120° (V/H)  
 cz: rozsah čidla pohybu 30°/120° (V/H)  
 sk: uhol činnosti pohybového čidla 30°/120° (V/H)

PL: W skład oprawy wchodzi wbudowane lampy LED  
 cz: Toto svítidlo obsahuje zabudované světelné zdroje LED  
 sk: Toto svietidlo obsahuje zabudované svetelné zdroje LED

PL: Nie można wymieniać lamp w oprawie  
 cz: Světelné zdroje v tomto svítidle nelze vyměnit  
 sk: Svetelné zdroje v svietidle sa nedajú vymeniť



1 PUMA 10 LED 6400K



2 PUMA 20 LED 6400K



3 PUMA 30 LED 6400K



4 PUMA 50 LED 6400K



5 PUMA 100 LED 6400K



6 PUMA/S-10 LED 6400K



7 PUMA/S-20 LED 6400K



8 PUMA/S-30 LED 6400K



9 PUMA/S-50 LED 6400K

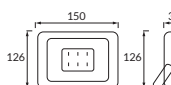

1 PUMA 10 LED 6400K

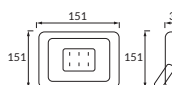

2 PUMA 20 LED 6400K

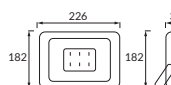

3 PUMA 30 LED 6400K

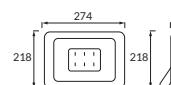

4 PUMA 50 LED 6400K

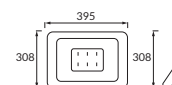

5 PUMA 100 LED 6400K

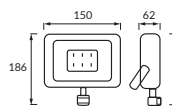

6 PUMA/S-10 LED 6400K

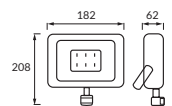

7 PUMA/S-20 LED 6400K

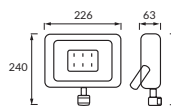

8 PUMA/S-30 LED 6400K

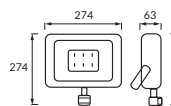

9 PUMA/S-50 LED 6400K

220-240V~	SMD LED	IP65	Tc (K) 5000K-6500K
120°	CRI >70	20000h	50000h
IP65	65	0,5	
CE			

	01234	ABCDE						
1	02946	PUMA 10 LED 6400K	10 W	500 lm	czarny czarna czarna	zimmobiata studená biela studená biela	X	5901477329463
2	02948	PUMA 20 LED 6400K	20 W	1000 lm				5901477329487
3	02950	PUMA 30 LED 6400K	30 W	1500 lm				5901477329500
4	02952	PUMA 50 LED 6400K	50 W	2500 lm				5901477329524
5	02954	PUMA 100 LED 6400K	100 W	5000 lm				5901477329548
6	02957	PUMA/S-10 LED 6400K	10 W	500 lm	✓	PIR	5901477329579	
7	02958	PUMA/S-20 LED 6400K	20 W	1000 lm			5901477329586	
8	02959	PUMA/S-30 LED 6400K	30 W	1500 lm			5901477329593	
9	02961	PUMA/S-50 LED 6400K	50 W	2500 lm			5901477329616	

### Materiał / Materiál / Material

PL: aluminium, szkło  
CZ: hliník, sklo  
SK: hliník, sklo

### Uwagi / Komentář / Komentáre

PL: zasilacz w komplecie  
CZ: napájecí zdroj je součástí dodávky  
SK: napájecí zdroj je súčasťou dodávky

### 6...9 PUMA/S

### Uwagi / Komentář / Komentáre

PL: zasięg wykrywania ruchu max 12m (<24°C)  
CZ: maximální dosah čidla 12m (<24°C)  
SK: maximálny dosah čidla 12m (<24°C)

### Uwagi / Komentář / Komentáre

PL: regulacja czasu świecenia od 12s do 6min  
CZ: možnost regulace doby svícení od 12s do 6min  
SK: možnosť regulácie doby svietenia od 12s do 6min

### Uwagi / Komentář / Komentáre

PL: kął wykrywania ruchu 30°/120° (V/H)  
CZ: rozsah čidla pohybu 30°/120° (V/H)  
SK: uhol činnosti pohybového čidla 30°/120° (V/H)

### 6...9 PUMA/S

### Uwagi / Komentář / Komentáre

PL: regulacja położenia czujnika ruchu 180°/160° (V/H)  
CZ: regulácia pozície pohybového senzora 180°/160° (V/H)  
SK: regulácie pozície pohybového čidla 180°/160° (V/H)

### Uwagi / Komentář / Komentáre

PL: możliwość ustawienia poziomu natężenia oświetlenia otoczenia (10-2000lx)  
CZ: možnost nastavení úrovně osvětlení (10-2000lx), při němž zařízení pracuje  
SK: možnosť nastavenia úrovne osvetlenia (10-2000lx), pri ktorom zariadenie pracuje

PL: W skład oprawy wchodzi wbudowane lampy LED  
CZ: Toto svítidlo obsahuje zabudované světelné zdroje LED  
SK: Toto svetidlo obsahuje zabudované svetelné zdroje LED

PL: Nie można wymieniać lamp w oprawie  
CZ: Světelné zdroje v tomto svítidle nelze vyměnit  
SK: Svetelné zdroje v svetidle sa nedajú vymeniť



# MARAT CBS-37x

Rozdzielnica z listwami przyłączeniowymi PEIN

cz: Plastový rozvaděč s DIN lištou / sk: Plastový rozvádzač s DIN lištou



1 MARAT CBS-375



2 MARAT CBS-377



3 MARAT CBS-379



4 MARAT2 CBS-376



5 MARAT2 CBS-378



**Materiał / Materiál / Material**

PL: ABS, MDF

CZ: ABS, MDF

SK: ABS, MDF

1 4

**Uwagi / Komentář / Komentáre**

PL: 8 pól

CZ: 8 modulů

SK: 8 modulov

2 5

**Uwagi / Komentář / Komentáre**

PL: 12 pól

CZ: 12 modulů

SK: 12 modulov

3

**Uwagi / Komentář / Komentáre**

PL: 24 pola

CZ: 24 modulů

SK: 24 modulov

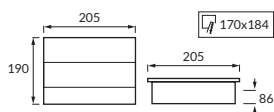

1 MARAT CBS-375  
4 MARAT2 CBS-376

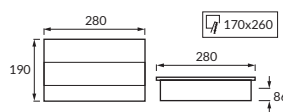

2 MARAT CBS-377  
5 MARAT2 CBS-378

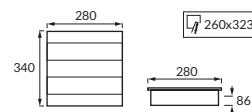

3 MARAT CBS-379

	01234	ABCDE		
1	00375	MARAT CBS-375	olcha+srebrny olše+stříbrná jelša+strieborná	5901477303753
2	00377	MARAT CBS-377		5901477303777
3	00379	MARAT CBS-379		5901477303791
4	00376	MARAT2 CBS-376	mahoň+srebrny mahagon+stříbrná mahogón+strieborná	5901477303760
5	00378	MARAT2 CBS-378		5901477303784





1 MARAT3 CBS-381

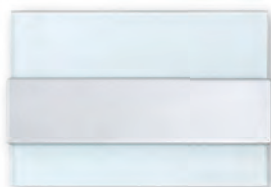

2 MARAT3 CBS-383

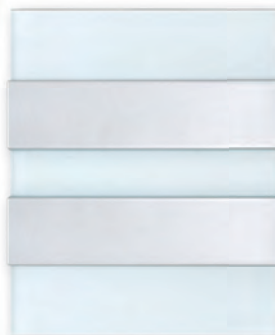

3 MARAT3 CBS-385



6 MARAT4 CBS-386



4 MARAT4 CBS-382



5 MARAT4 CBS-384

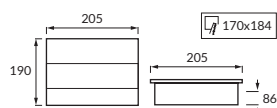

1 MARAT3 CBS-381  
4 MARAT4 CBS-382

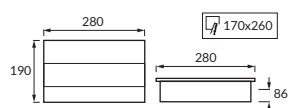

2 MARAT3 CBS-383  
5 MARAT4 CBS-384

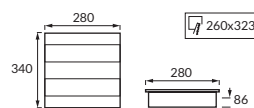

3 MARAT3 CBS-385  
6 MARAT4 CBS-386



### Materiał / Materiál / Material

PL: ABS, szkło

CZ: ABS, sklo

SK: ABS, sklo

### 1 4 MARAT CBS-381/382

#### Uwagi / Komentář / Komentáre

PL: 8 pól

CZ: 8 modulů

SK: 8 modulov

### 2 5 MARAT CBS-383/384

#### Uwagi / Komentář / Komentáre

PL: 12 pól

CZ: 12 modulů

SK: 12 modulov

### 3 6 MARAT CBS-385/386

#### Uwagi / Komentář / Komentáre

PL: 24 pola

CZ: 24 modulů

SK: 24 modulov

Icon	01234	ABCDE	Icon	Barcode
1	00381	MARAT3 CBS-381		5901477303814
2	00383	MARAT3 CBS-383	biały+srebrny / bílá+stříbrná / biely+strieborná	5901477303838
3	00385	MARAT3 CBS-385		5901477303852
4	00382	MARAT4 CBS-382		5901477303821
5	00384	MARAT4 CBS-384	czarny+srebrny / černá+stříbrná / čierna+strieborná	5901477303845
6	00386	MARAT4 CBS-386		5901477303869

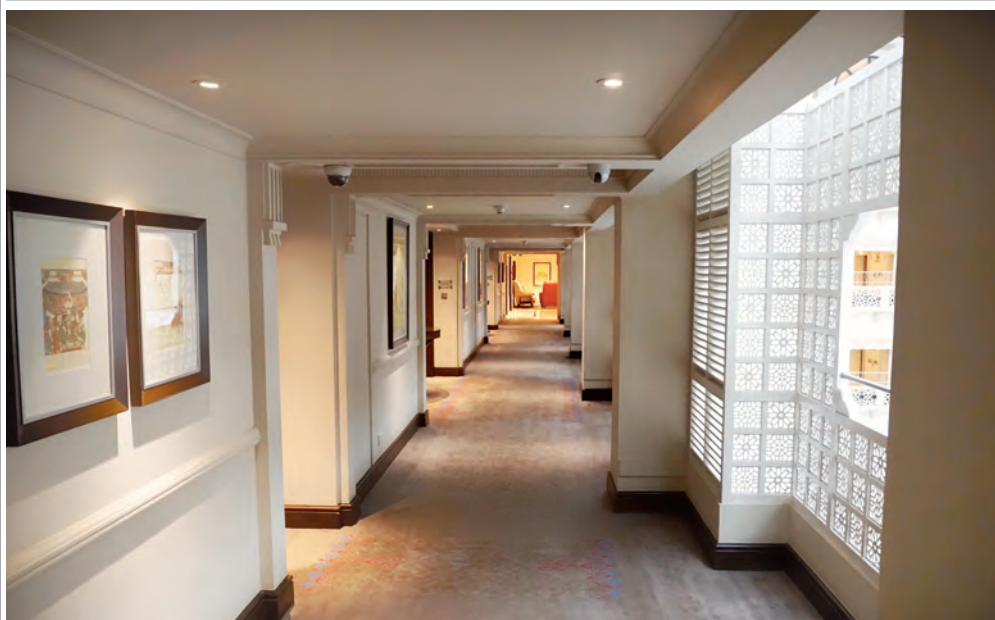

# VEGA / TRANSFORMER

Zasilacz elektroniczny

cz: Elektronický transformátor / sk: Elektronický transformátor



1 VEGA 36



2 TRANSFORMER-60 HL370 60W



3 TRANSFORMER-105 HL371 105W



4 TRANSFORMER-150 HL372 150W

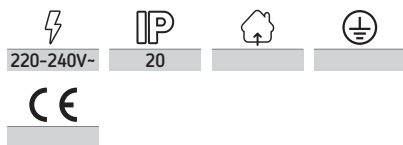

**Materiał / Materiál / Material**

PL: blacha stalowa  
 CZ: kovový výlisek  
 SK: kovový výlisok

1 VEGA 36

**Uwagi / Komentář / Komentáre**

PL: napięcie wyjściowe SEC 12 V DC, 3A  
 CZ: výstupní napětí SEC 12 V DC, 3A  
 SK: výstupné napätie SEC 12 V DC, 3A

2 3 4 TRANSFORMER

**Uwagi / Komentář / Komentáre**

PL: napięcie wyjściowe SEC 12 V  
 CZ: výstupní napětí SEC 12 V  
 SK: výstupné napätie SEC 12 V

1 VEGA 36

**Uwagi / Komentář / Komentáre**

PL: zasilacz elektroniczny do LED  
 CZ: elektronický napájecí zdroj pro LED  
 SK: elektronický napájecí zdroj pro LED

2 3 4 TRANSFORMER

**Uwagi / Komentář / Komentáre**

PL: zasilacz elektroniczny  
 CZ: elektronický napájecí zdroj  
 SK: elektronický napájecí zdroj



1 VEGA 36

2 3 4 TRANSFORMER

	01234	ABCDE			
1	03082	VEGA 36	chrom / chrom / chrom	max 36 W	5901477330827
2	00833	TRANSFORMER-60 HL370 60W	biały / biał / biał	max 60 W	5901477308338
3	00834	TRANSFORMER-105 HL371 105W	biały / biał / biał	max 105 W	5901477308345
4	00835	TRANSFORMER-150 HL372 150W	biały / biał / biał	max 150 W	5901477308352







1 FOCUS HL480 WHITE



2 LINEA HL482 WHITE



3 HL485 WHITE



4 HL486 WHITE



5 HL470 1000W

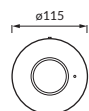

1 FOCUS HL480 WHITE

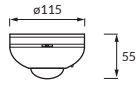

2 LINEA HL482 WHITE

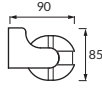

3 HL485 WHITE

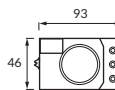
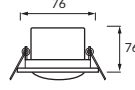

4 HL486 WHITE

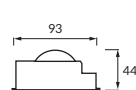

5 HL470 1000W



220-240V-

Materiál / Materiál / Material

PL: tworzywo sztuczne

cz: plast

sk: plast

Icon	Code	Model	Power	Color	Wireless	PIR	MICRO	IP	Icon	Barcode
1	01841	FOCUS HL480 WHITE	max 1000 W	biały biłá biely	×	PIR ✓	×	20	♻️	5901477318412
2	01845	LINEA HL482 WHITE			×	PIR ✓	✓	44	♻️	5901477318450
3	02496	HL485 WHITE			×	PIR ✓	×	20	♻️	5901477324963
4	02698	HL486 WHITE	max 1200 W	biely	×	MICRO ✓	×	20	♻️	5901477326981
5	01563	HL470 1000W			max 1000 W (6A)	biały+niebieski / biłá+modrá / biely+modrá	✓	×	×	44

1 3 4

### Uwagi / Komentář / Komentáre

PL: kąt działania czujnika 360°

CZ: rozsah čidla pohybu 360°

SK: uhol činnosti pohybového čidla 360°

2

### Uwagi / Komentář / Komentáre

PL: kąt działania czujnika 180°

CZ: rozsah čidla pohybu 180°

SK: uhol činnosti pohybového čidla 180°

1 2 4

### Uwagi / Komentář / Komentáre

PL: zasięg wykrywania ruchu max 8m (<24°C)

CZ: maximální dosah čidla 8m (<24°C)

SK: maximálny dosah čidla 8m (<24°C)

3

### Uwagi / Komentář / Komentáre

PL: zasięg wykrywania ruchu max 6m (<24°C)

CZ: maximální dosah čidla 6m (<24°C)

SK: maximálny dosah čidla 6m (<24°C)

1 2

### Uwagi / Komentář / Komentáre

PL: regulacja czasu świecenia od 5s do 8min

CZ: možnost regulace doby svícení od 5s do 8min

SK: možnost regulácie doby svietenia od 5s do 8min

3

### Uwagi / Komentář / Komentáre

PL: regulacja czasu świecenia od 10s do 7min

CZ: možnost regulace doby svícení od 10s do 7min

SK: možnost regulácie doby svietenia od 10s do 7min

4

### Uwagi / Komentář / Komentáre

PL: regulacja czasu świecenia od 10s do 12min

CZ: možnost regulace doby svícení od 10s do 12min

SK: možnost regulácie doby svietenia od 10s do 12min

1 2

### Uwagi / Komentář / Komentáre

PL: możliwość ustawienia poziomu natężenia oświetlenia otoczenia (10-2000lx), przy którym urządzenie pracuje

CZ: možnost nastavení úrovně osvětlení (10-2000lx), při němž zařízení pracuje

SK: možnost nastavenia úrovne osvetlenia (10-2000lx), pri ktorom zariadenie pracuje

3 4

### Uwagi / Komentář / Komentáre

PL: możliwość ustawienia poziomu natężenia oświetlenia otoczenia (3-2000lx), przy którym urządzenie pracuje

CZ: možnost nastavení úrovně osvětlení (3-2000lx), při němž zařízení pracuje

SK: možnost nastavenia úrovne osvetlenia (3-2000lx), pri ktorom zariadenie pracuje

5

### Uwagi / Komentář / Komentáre

PL: działa przy świetle otoczenia poniżej 50lx

CZ: působí na okolní světlo pod 50lx

SK: působí na okolité svetlo pod 50lx

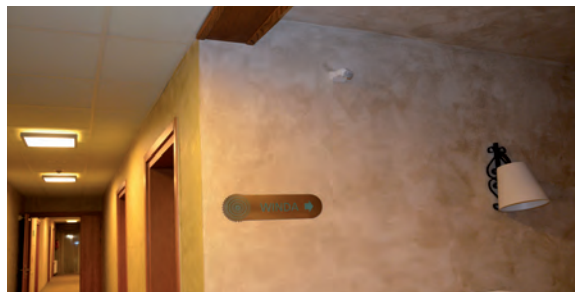

# HELIX / ALBA / VIOLA / SOLO

## Minialarm / Dzwonek bezprzewodowy

cz: Minialarm / Bezdrátový zvonček sk: Minialarm / Bezdrátový zvonček



1 HELIX HL454 60DB



2 ALBA HL455 60DB



3 VIOLA HL456 60DB



4 SOLO HL457 60DB



### Materiał / Materiál / Material

PL: tworzywo sztuczne

CZ: plast

SK: plast

### 1 HELIX

#### Uwagi / Komentář / Komentáre

PL: głośność alarmu 60 db.

CZ: hladina hluku 60 db.

SK: hladina hluku 60 db.

### 2 3 4 ALBA / VIOLA / SOLO

#### Uwagi / Komentář / Komentáre

PL: głośność dzwoneka 60 db.

CZ: hladina hluku 60 db.

SK: hladina hluku 60 db.

### 1 HELIX

#### Uwagi / Komentář / Komentáre

PL: wykrywanie ruchu do 6m w promieniu 110°

CZ: dosah čidla pohybu do 6 m v rozsahu 110°

SK: detekcia pohybu do 6m v rozsahu 110°

### 1 HELIX

#### Uwagi / Komentář / Komentáre

PL: 3 rodzaje dźwięków

CZ: 3 zvuků

SK: 3 zvukov

### 2 3 4 ALBA / VIOLA / SOLO

#### Uwagi / Komentář / Komentáre

PL: dystans max 120 m

CZ: vzdálenost max 120 m

SK: vzdialenost max 120 m

### 2 3 4 ALBA / VIOLA / SOLO

#### Uwagi / Komentář / Komentáre

PL: 38 dźwięków

CZ: 38 zvuků

SK: 38 zvukov

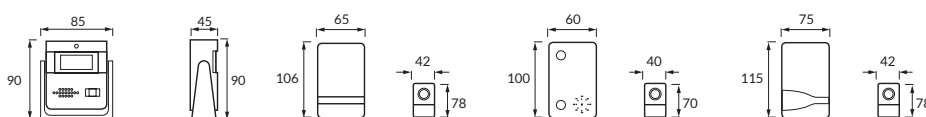

1 HELIX HL454 60DB

2 ALBA HL455 60DB

3 VIOLA HL456 60DB

4 SOLO HL457 60DB

	01234	ABCDE	⚡	📡	👤	📊
1	00739	HELIX HL454 60DB	4,5V DC (3xAA1,5V)		PIR ✓	5901477307393
2	02387	ALBA HL455 60DB	12V / 4,5V	biały biła biely	×	5901477323874
3	02388	VIOLA HL456 60DB			×	5901477323881
4	02389	SOLO HL457 60DB			×	5901477323898





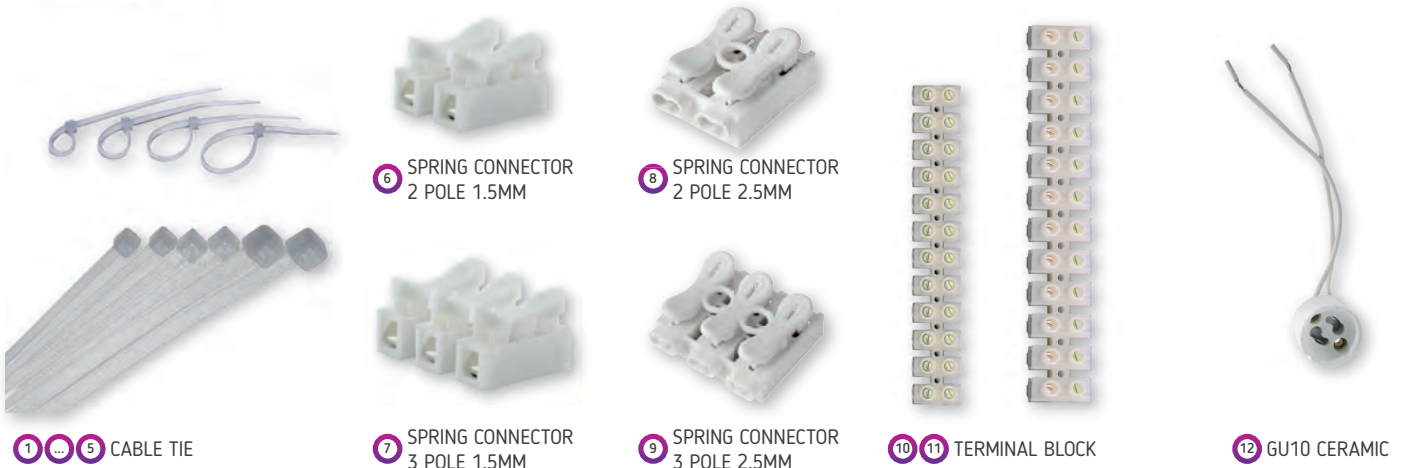

1 ... 5 CABLE TIE

6 SPRING CONNECTOR 2 POLE 1.5MM

8 SPRING CONNECTOR 2 POLE 2.5MM

7 SPRING CONNECTOR 3 POLE 1.5MM

9 SPRING CONNECTOR 3 POLE 2.5MM

10 11 TERMINAL BLOCK

12 GU10 CERAMIC

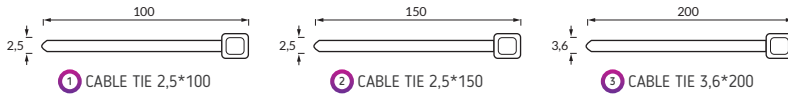

1 CABLE TIE 2,5\*100

2 CABLE TIE 2,5\*150

3 CABLE TIE 3,6\*200

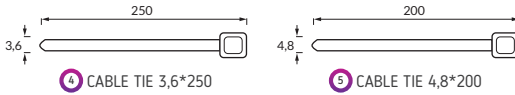

4 CABLE TIE 3,6\*250

5 CABLE TIE 4,8\*200

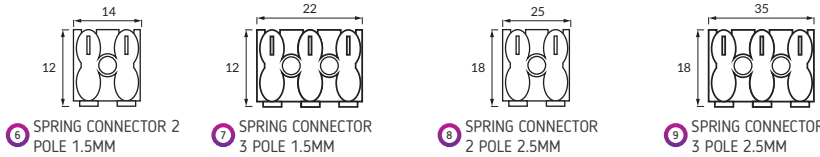

6 SPRING CONNECTOR 2 POLE 1.5MM

7 SPRING CONNECTOR 3 POLE 1.5MM

8 SPRING CONNECTOR 2 POLE 2.5MM

9 SPRING CONNECTOR 3 POLE 2.5MM

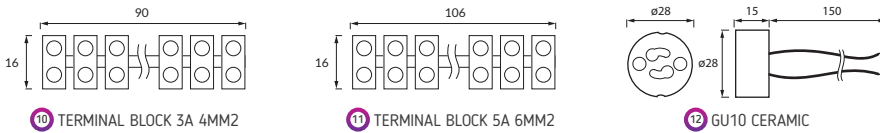

10 TERMINAL BLOCK 3A 4MM2

11 TERMINAL BLOCK 5A 6MM2

12 GU10 CERAMIC

1 ... 5

**Materiał / Materiál / Material**

PL: tworzywo sztuczne

CZ: plast

SK: plast

6 ... 11

**Materiał / Materiál / Material**

PL: polietylen PE

CZ: polyetylen PE

SK: polyetylén PE

12

**Materiał / Materiál / Material**

PL: ceramika

CZ: keramika

SK: keramika

1 ... 9

**Uwagi / Komentář / Komentáre**

PL: 100 szt. w opakowaniu jednostkowym

CZ: 100 produkty v balení

SK: 100 produkty v balení

1 ... 9

**Uwagi / Komentář / Komentáre**

PL: cena podawana jest za jedno opakowanie (tj. za sto sztuk)

CZ: cena za jeden balíček (sto kusů)

SK: cena za jeden balíček (sto kusov)

6 7 8 9 12

**Uwagi / Komentář / Komentáre**

PL: max 5 A max 10 A max 2 A

CZ: max 5 A max 10 A max 2 A

SK: max 5 A max 10 A max 2 A

12

**Uwagi / Komentář / Komentáre**

PL: przewód o długości 15 cm

CZ: kabel o délce 15 cm

SK: kábel o dĺžke 15 cm

	01234	ABCDE						
1	00515	CABLE TIE 2,5*100	-					5901477305153
2	00516	CABLE TIE 2,5*150						5901477305160
3	00519	CABLE TIE 3,6*200						5901477305191
4	00520	CABLE TIE 3,6*250						5901477305207
5	00525	CABLE TIE 4,8*200						5901477305252
6	02546	SPRING CONNECTOR 2 POLE 1.5MM	max 380V-	biały biłá biely	-			5901477325465
7	02547	SPRING CONNECTOR 3 POLE 1.5MM						5901477325472
8	03057	SPRING CONNECTOR 2 POLE 2.5MM						5901477330575
9	03058	SPRING CONNECTOR 3 POLE 2.5MM	max 250V-			✓		5901477330582
10	01968	TERMINAL BLOCK 3A 4MM2						5901477319686
11	01969	TERMINAL BLOCK 5A 6MM2						5901477319693
12	02542	GU10 CERAMIC						5901477325427



# T8 LED

## Tuba T8 SMD LED

cz: Lineární zářivka SMD LED / sk: Lineárna žiarivka SMD LED



1 T8 LED 9W 4000K 0,6



2 T8 LED 18W 4000K 1,2

220-240V~	SMD LED	G13	
4000K	320°	>80	20000h



### Materiał / Materiál / Material

PL: tworzywo sztuczne, szkło  
CZ: plast, sklo  
SK: plast, sklo

### Uwagi / Komentář / Komentáre

PL: zasilana jednostronnie  
CZ: jednostranné napájanie  
SK: jednostranné napájanie



1 T8 LED 9W 4000K 0,6

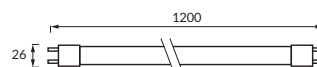

2 T8 LED 18W 4000K 1,2

1	01234	ABCDE	02931	T8 LED 9W 4000K 0,6	9 W	800 lm	biały biła	neutralna biała neutrálne biła	5901477329319
2			02932	T8 LED 18W 4000K 1,2	18 W	1600 lm	biely	neutrálne biele	5901477329326



1 T8 LED 9W 4000K 0,6

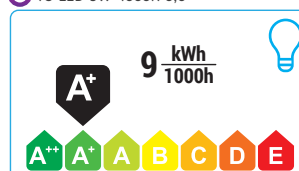

2 T8 LED 18W 4000K 1,2

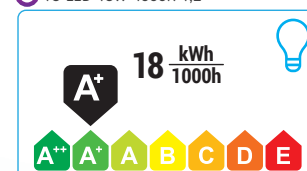



1 ERSTE LED  
E27 8W 3000K



2 ERSTE LED  
3 ERSTE LED  
E27 10W



4 ERSTE LED  
5 ERSTE LED  
E27 12W



6 ERSTE LED  
7 ERSTE LED  
E27 14W

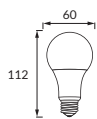

1 ERSTE LED E27  
2 8W/10W

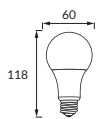

4 ERSTE LED  
E27 12W 3000K

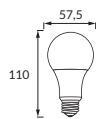

3 5 ERSTE LED E27  
6 7 10W/12W/14W

220-240V~	SMD LED	E27	
270°	CRI >80	25000h	

1	01234	ABCDE					Tc IK1 S0CM6	
1	02753	ERSTE LED E27 8W 3000K	8 W	640 lm	biały biła biely	ciepłobiała / teplá bilá / teplá biela	3000K	5901477327537
2	02754	ERSTE LED E27 10W 3000K	10 W	850 lm		ciepłobiała / teplá bilá / teplá biela	3000K	5901477327544
3	02794	ERSTE LED E27 10W 4500K				neutralna biela / neutrální bilá / neutrálna biela	4500K	5901477327940
4	02755	ERSTE LED E27 12W 3000K	12 W	1050lm		ciepłobiała / teplá bilá / teplá biela	3000K	5901477327551
5	02795	ERSTE LED E27 12W 4500K				neutralna biela / neutrální bilá / neutrálna biela	4500K	5901477327957
6	03059	ERSTE LED E27 14W 3000K	14 W	1250lm		ciepłobiała / teplá bilá / teplá biela	3000K	5901477330599
7	03060	ERSTE LED E27 14W 4500K				neutralna biela / neutrální bilá / neutrálna biela	4500K	5901477330605



### Materiál / Materiál / Material

PL: poliwęglan PC, aluminium

cz: polykarbonát PC, hliník

sk: polykarbonát PC, hliník

1 ERSTE LED E27 8W



2 3 ERSTE LED E27 10W

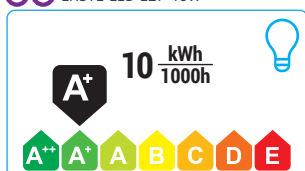

4 5 ERSTE LED E27 12W

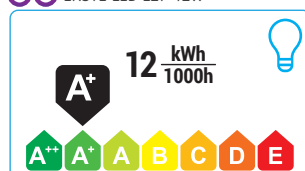

6 7 ERSTE LED E27 14W

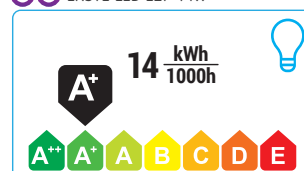

# VELA / ULKE LED

Lampa z diodami SMD LED

cz: Světelný zdroj SMD LED / sk: Svetelný zdroj SMD LED



1 VELA LED  
2 E14 4W/6W



3 ULKE LED  
4 E14 4W/6W



5 ULKE LED  
6 E27 4W/6W

220-240V-	SMD LED	3000K
180°	CRI >80	25000h

**Materiał / Materiál / Material**

PL: poliwęglan PC, aluminium

CZ: polykarbonát PC, hliník

SK: polykarbonát PC, hliník

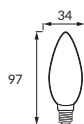

1 VELA LED E14  
2 4W/6W

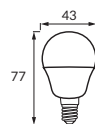

3 ULKE LED E14  
4 4W/6W

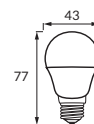

5 ULKE LED E27  
6 4W/6W

	01234	ABCDE						
1	02799	VELA LED E14 4W 3000K	4 W	320 lm	biely bilá biely	ciepłobiła teplá bílá teplá biela	E14	5901477327995
2	02801	VELA LED E14 6W 3000K	6 W	480 lm				5901477328015
3	02803	ULKE LED E14 4W 3000K	4 W	320 lm				5901477328039
4	02805	ULKE LED E14 6W 3000K	6 W	480 lm				5901477328053
5	03061	ULKE LED E27 4W 3000K	4 W	320 lm	E27	5901477330612		
6	03062	ULKE LED E27 6W 3000K	6 W	480 lm		5901477330629		



1 3 5

**A<sup>+</sup>** 4 kWh / 1000h

A<sup>++</sup> A<sup>+</sup> A B C D E

2 4 6

**A<sup>+</sup>** 6 kWh / 1000h

A<sup>++</sup> A<sup>+</sup> A B C D E





1 FILAMENT LED  
2 FLAME-2

3 FILAMENT LED  
4 FLAME-4

5 FILAMENT LED  
6 GLOBE-4

7 FILAMENT LED  
8 GLOBE-6

9 FILAMENT LED  
10 GLOBE-8

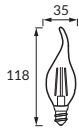

1 3 FILAMENT LED  
2 4 FLAME

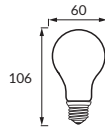

5 7 9 FILAMENT LED  
6 8 10 GLOBE

220-240V-	COG LED	CE	160°
CRI >80	20000h		

1	01234	ABCDE						
1	02994	FILAMENT LED FLAME-2 2700K	2 W	160 lm	ciepłobiąta / teplá bílá / teplá biela	2700K	E14	5901477329944
2	02995	FILAMENT LED FLAME-2 4200K			neutralna biąta / neutrální bílá / neutrálna biela	4000K		5901477329951
3	02996	FILAMENT LED FLAME-4 2700K	4 W	320 lm	ciepłobiąta / teplá bílá / teplá biela	2700K		5901477329968
4	02997	FILAMENT LED FLAME-4 4200K			neutralna biąta / neutrální bílá / neutrálna biela	4000K		5901477329975
5	02998	FILAMENT LED GLOBE-4 2700K	4 W	320 lm	ciepłobiąta / teplá bílá / teplá biela	2700K		5901477329982
6	02999	FILAMENT LED GLOBE-4 4200K			neutralna biąta / neutrální bílá / neutrálna biela	4000K		5901477329999
7	03000	FILAMENT LED GLOBE-6 2700K	6 W	400 lm	ciepłobiąta / teplá bílá / teplá biela	2700K		5901477330001
8	03001	FILAMENT LED GLOBE-6 4200K			neutralna biąta / neutrální bílá / neutrálna biela	4000K		5901477330018
9	03002	FILAMENT LED GLOBE-8 2700K	8 W	500 lm	ciepłobiąta / teplá bílá / teplá biela	2700K		5901477330025
10	03003	FILAMENT LED GLOBE-8 4200K			neutralna biąta / neutrální bílá / neutrálna biela	4000K		5901477330032



<b>Materiał / Materiál / Material</b>
PL: szkło
CZ: sklo
SK: sklo

<p>1 2</p> <p><b>A<sup>+</sup></b> 2 kWh / 1000h</p> <p>A<sup>++</sup> A<sup>+</sup> A B C D E</p>	<p>3 4 6</p> <p><b>A<sup>+</sup></b> 4 kWh / 1000h</p> <p>A<sup>++</sup> A<sup>+</sup> A B C D E</p>	<p>7 8</p> <p><b>A<sup>+</sup></b> 6 kWh / 1000h</p> <p>A<sup>++</sup> A<sup>+</sup> A B C D E</p>	<p>9 10</p> <p><b>A<sup>+</sup></b> 8 kWh / 1000h</p> <p>A<sup>++</sup> A<sup>+</sup> A B C D E</p>
--	--	--	---

# RAINBOW LED

## Lampa dekoracyjna SMD LED

cz: Dekorační světelný zdroj SMD LED / sk: Dekoračný svetelný zdroj SMD LED



1 RAINBOW LED  
1W BLUE



2 RAINBOW LED  
1W YELLOW



3 RAINBOW LED  
1W RED



4 RAINBOW LED  
1W GREEN

220-240V~	SMD LED	1W	E27
200°	>65		20000h

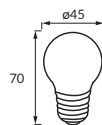

1 2 3 4 RAINBOW LED

Materiał / Materiál / Material	
PL:	tworzywo sztuczne
CZ:	plast
SK:	plast
Uwagi / Komentár / Komentáre	
PL:	produkt dekoracyjny
CZ:	dekorační výrobek
SK:	dekoračné výrobok

1	01234	ABCDE	12 lm	niebieski / modrá / modrá	5901477329753
2	02976	RAINBOW LED 1W YELLOW	105 lm	żółty / žltá / žltá	5901477329760
3	02977	RAINBOW LED 1W RED	34 lm	czerwony / červená / červená	5901477329777
4	02978	RAINBOW LED 1W GREEN	68 lm	zielony / zelený / zelený	5901477329784



<p>1 kWh / 1000h</p> <p><b>B</b></p> <p>A++ A+ A B C D E</p>	<p>1 kWh / 1000h</p> <p><b>A++</b></p> <p>A++ A+ A B C D E</p>	<p>1 kWh / 1000h</p> <p><b>A+</b></p> <p>A++ A+ A B C D E</p>
--	--	---



1 R39 30W FROSTED



2 R50 40W FROSTED



3 R50 60W FROSTED



4 R63 60W FROSTED

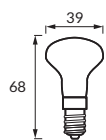

1 R39

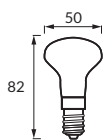

2 3 R50

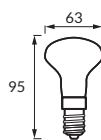

4 R63

220-240V~	2700K		60°
CRI 100	1000h		

Icon	01234	ABCDE	W	lm	Color	Base	Barcode
1	01794	R39 30W FROSTED	30 W	150 lm	ciepłobiała teplá bílá teplá biela	E14	5901477317941
2	01802	R50 40W FROSTED	40 W	280 lm			5901477318023
3	01803	R50 60W FROSTED	60 W	460 lm		5901477318030	
4	01809	R63 60W FROSTED		400 lm		E27	5901477318092



1 30 kWh / 1000h

A+ A A B C D E

2 40 kWh / 1000h

A+ A A B C D E

3 4 60 kWh / 1000h

A+ A A B C D E



# LARA LED

## Lampa SMD LED

cz: Světelný zdroj SMD LED / sk: Svetelný zdroj SMD LED



1 LARA LED GU10 4W 3000K



2 LARA LED GU10 6W 3000K

220-240V~	SMD LED	GU10	
3000K	120°	>80	25000h

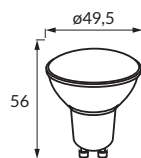

1 2 LARA LED

Materiał / Materiál / Material	
PL:	poliwęglan PC, aluminium
CZ:	polykarbonát PC, hliník
SK:	polykarbonát PC, hliník

1	01234	ABCD E	4 W	320 lm	biely	ciepłobiała	5901477327575
2	02758	LARA LED GU10 6W 3000K	6 W	410 lm	biely	teplá biela	5901477327582



1 LARA LED GU10 4W 3000K

**A<sup>+</sup>** 4 kWh/1000h

2 LARA LED GU10 6W 3000K

**A<sup>+</sup>** 6 kWh/1000h



1 BIT SMD LED G9 2,5W 3000K

2 BIT SMD LED G9 2,5W 4500K

3 BIT SMD LED G9 2,5W 6500K

4 MEGA-3 HL457L 3W 2700K

5 MEGA-3 HL457L 3W 6400K

6 MEGA-5 HL458L 5W 2700K

7 MEGA-5 HL458L 5W 6400K

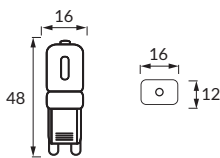

1 2 3 BIT SMD LED

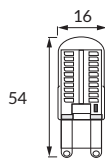

4 5 6 7 MEGA

220-240V- SMD LED G9 CRI Ra >80

1	01234	ABCDE				Tc (K) SDCMS				
1	02765	BIT SMD LED G9 2,5W 3000K				3000K	✓			5901477327650
2	02549	BIT SMD LED G9 2,5W 4500K	2,5 W	200 lm	ciepłobiała / teplá bílá / teplá biela	4500K	✓	300°	25000h	5901477325496
3	02766	BIT SMD LED G9 2,5W 6500K			neutralna biela / neutrální bílá / neutrálna biela	6500K	✓			5901477327667
4	02712	MEGA-3 HL457L 3W 2700K			zimnobiała / studená bílá / studená biela	2700K	×			5901477327124
5	02713	MEGA-3 HL457L 3W 6400K	3 W	180 lm	ciepłobiała / teplá bílá / teplá biela	6500K	×	280°	20000h	5901477327131
6	02714	MEGA-5 HL458L 5W 2700K			neutralna biela / neutrální bílá / neutrálna biela	2700K	×			5901477327148
7	02715	MEGA-5 HL458L 5W 6400K	5 W	230 lm	zimnobiała / studená bílá / studená biela	6500K	×			5901477327155

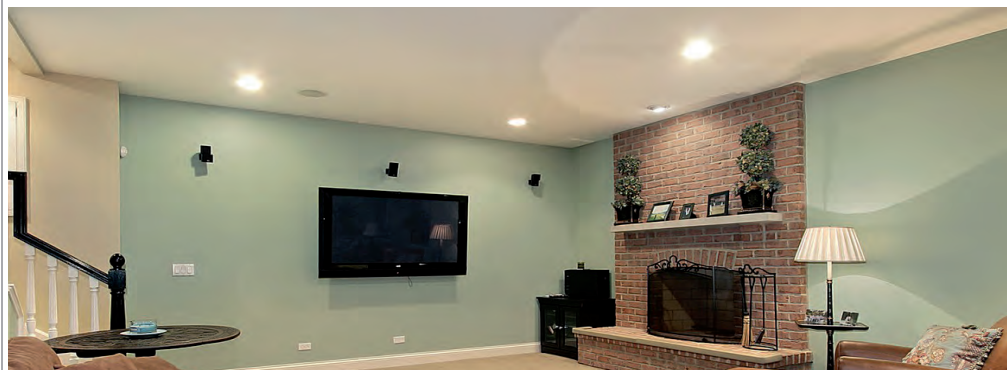

1 2 3 BIT SMD LED

**Materiał / Materiál / Materiál**

PL: tworzywo sztuczne

CZ: plast

SK: plast

4 5 6 7 MEGA

**Materiał / Materiál / Materiál**

PL: szkło

CZ: sklo

SK: sklo

1 2 3 BIT SMD LED

**A<sup>++</sup>** 2,5 kWh / 1000h

4 5 MEGA-3

**A<sup>+</sup>** 3 kWh / 1000h

6 7 MEGA-5

**A<sup>+</sup>** 5 kWh / 1000h

## Żarówka halogenowa

**CZ:** Halogenová žárovka / **SK:** Halogénová žiarovka



1 G9 25W CLEAR



2 G9 40W CLEAR

220-240V~	G9	2700K	
200°	CRI 100	2000h	

**Materiał / Materiál / Material**

PL: szkło

CZ: sklo

SK: sklo

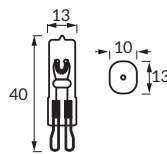

1 2 G9

	01234	ABCDE				
1	01346	G9 25W CLEAR	25 W	320 lm	ciepłobiała teplá bílá teplá biela	5901477313462
2	01349	G9 40W CLEAR	40 W	590 lm		5901477313493



1 G9 25W CLEAR

25 kWh / 1000h

**C**

A+ A+ A B C D E

2 G9 40W CLEAR

40 kWh / 1000h

**C**

A+ A+ A B C D E





1 JCDR CLOSED 35W



2 JCDR CLOSED 50W

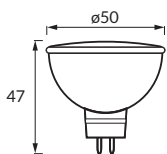

1 2 JCDR CLOSED

220-240V~	GU5.3	2700K	
35°	100	2000h	

**Materiał / Materiál / Materiál**

PL: szkło

CZ: sklo

SK: sklo

**Uwagi / Komentář / Komentáre**

PL: z szybką ochronną

CZ: s ochranným sklem

SK: s ochranným sklom

	01234	ABCDE				
1	01387	JCDR CLOSED 35W	35 W	320 lm	ciepłobiała teplá biela	5901477313875
2	01388	JCDR CLOSED 50W	50 W	550 lm	teplá biela	5901477313882



1 JCDR CLOSED 35W

2 JCDR CLOSED 50W

35 kWh / 1000h

**D**

A+ A+ A B C D E

50 kWh / 1000h

**D**

A+ A+ A B C D E

# J 118MM

## Projektorowa żarówka halogenowa

cz: Halogenová žárovka lineární / sk: Halogénová žiarovka lineárna



① J 118MM 200W



② J 118MM 300W



③ J 118MM 500W

220-240V~	R7S	2700K	
280°	CRI [Ra]	2000h	
	100		

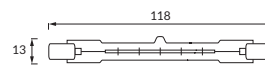

① ② ③ J 118MM

Materiał / Materiál / Material
PL: szkło
CZ: sklo
SK: sklo

	01234	ABCDE				
1	01362	J 118MM 200W	200 W	3400 lm	ciepłobiała	5901477313622
2	01363	J 118MM 300W	300 W	5100 lm	teplá bílá	5901477313639
3	01364	J 118MM 500W	500 W	8500 lm	teplá biela	5901477313646



① J 118MM 200W

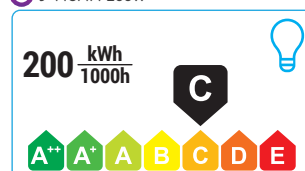

② J 118MM 300W

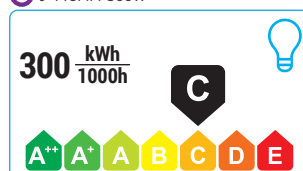

③ J 118MM 500W

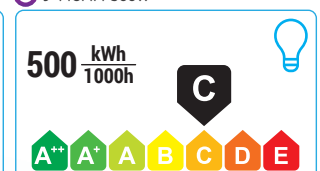

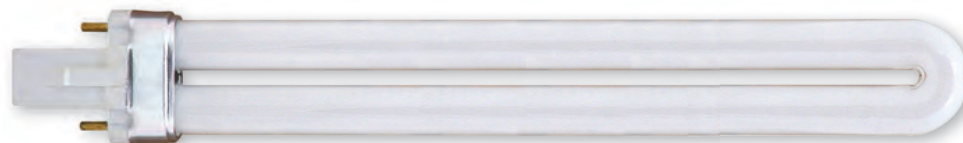

1 PL 11W 6400K



1 PL 11W 6400K

11 W	G23	6500K
520 lm	200°	>80

	01234	ABCDE		
1	00916	PL 11W 6400K	zimnobiała / studená bílá / studená biela	5901477309168

**Materiał / Materiál / Material**

PL: szkło  
CZ: sklo  
SK: sklo



1 PL 11W 6400K

**A** 11 kWh/1000h



# MIDI HL459L

## Lampa SMD LED

cz: Světelný zdroj SMD LED / sk: Svetelný zdroj SMD LED



① MIDI HL459L 1,5W 2700K



② MIDI HL459L 1,5W 6400K

12V DC	SMD LED	1,5 W	G4
110 lm	280°	CRI >80	[Ra]
20000h	CE		

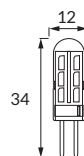

① ② MIDI HL459L

Materiał / Materiál / Material	
PL: szkło	
CZ: sklo	
SK: sklo	

	01234	ABCDE	TC (K) SDC46		
1	02716	MIDI HL459L 1,5W 2700K	2700K	ciepłobiała / teplá bílá / teplá biela	5901477327162
2	02717	MIDI HL459L 1,5W 6400K	6500K	zimnobiała / studená bílá / studená biela	5901477327179



① ② MIDI HL459L

**A<sup>+</sup>** 1,5 kWh / 1000h



1 JC G4 10W



2 JC G4 20W



3 JC G4 35W



4 JC G6.35 50W

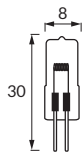

1 2 3 JC G4

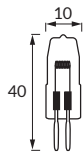

4 JC G6.35

12V	2700K		200°
100	2000h		

**Materiał / Materiál / Material**

PL: szkło

CZ: sklo

SK: sklo

01234	ABCDE						
1	01352	JC G4 10W	10 W	150 lm	ciepłobiała teplá bílá teplá biela	G4	5901477313523
2	01353	JC G4 20W	20 W	320 lm		G4	5901477313530
3	01354	JC G4 35W	35 W	600 lm		G4	5901477313547
4	01355	JC G6.35 50W	50 W	910 lm		G6.35	5901477313554



1 JC G4 10W

2 JC G4 20W

3 JC G4 35W

4 JC G6.35 50W

11 kWh / 1000h

**C**

A+ A+ A B C D E

22 kWh / 1000h

**C**

A+ A+ A B C D E

38 kWh / 1000h

**C**

A+ A+ A B C D E

53 kWh / 1000h

**C**

A+ A+ A B C D E

**PL: Nota prawna**

Niniejszy katalog został przygotowany przez Ideus Sp. z o.o. Zastrzegamy sobie prawo do wprowadzania zmian w przedstawionym asortymencie. Niniejszy katalog nie jest ofertą w rozumieniu Kodeksu Cywilnego. Rzeczywiste produkty mogą różnić się od produktów przedstawionych na zdjęciach, zaś dane techniczne rzeczywistych produktów mogą różnić się od danych prezentowanych w niniejszym katalogu. Wszystkie informacje przedstawione w katalogu obowiązują w dniu oddania go do druku tj. 30 stycznia 2017 r. Ideus Sp. z o.o. nie ponosi żadnej odpowiedzialności za brak dostępności produktów zamieszczonych w katalogu. Ideus Sp. z o.o. nie ponosi także odpowiedzialności za jakiegokolwiek bezpośrednio, pośrednio, przypadkowo lub jakiegokolwiek inne szkody (w tym również, ale nie wyłącznie, utracone zyski, utracone przychody lub inne straty ekonomiczne) powstałe w wyniku korzystania z informacji zawartych w niniejszym katalogu.

**CZ: Právní poznámka**

Tento katalog byl připraven firmou Ideus Sp. z. o.o. Vyhrazujeme si právo na provedení změn v prezentovaném sortimentu. Tento katalog nelze považovat za nabídku dle Občanského zákoníku. Skutečné produkty se mohou lišit od produktů prezentovaných na fotografiích a technická data skutečných produktů se mohou lišit od dat prezentovaných v tomto katalogu. Všechny informace prezentované v katalogu jsou platné ke dni vydání, tj. 30. ledna 2017. Ideus Sp. z o.o. nenesie žádnou odpovědnost za případnou nedostupnost produktů umístěných v katalogu. Ideus Sp. z o.o. nenesie také žádnou odpovědnost za jakékoliv přímé, nepřímé, náhodné či jakékoliv jiné škody (včetně ztráty zisku, ztráty výnosů nebo podobné ekonomické ztráty, bez omezení na uvedené ztráty) vzniklé v důsledku používání informací obsažených v tomto katalogu.

**SK: Právna poznámka**

Tento katalóg bol pripravený firmou Ideus Sp. z. o.o. Vyhradzujeme si právo na vykonanie zmien v prezentovanom sortimente. Tento katalóg nemožno považovať za ponuku podľa Občianskeho zákonníka. Skutočné produkty sa môžu líšiť od produktov prezentovaných na na fotografiách a technické dáta skutočných produktov sa môžu líšiť od údajov prezentovaných v tomto katalógu. Všetky informácie prezentované v katalógu sú platné ku dňu jeho vydania, tj. 30. januára 2017. Ideus Sp. z o.o. nenesie žiadnu zodpovednosť za akékoľvek iné škody (vrátane straty zisku, straty výnosov alebo podobné ekonomické straty, bez obmedzenia na uvedené straty) vzniknuté v dôsledku používania informácií obsiahnutých v tomto katalógu.



# Objaśnienia symboli i oznaczeń

**cz:** Vysvětlení symbolů a znaků / **sk:** Vysvetlenie symbolov a znakov

	PL: w komplecie / CZ: dodávky / SK: dodávky		GU10		PL: włącznik / CZ: spínač / SK: spínač
	PL: wymiary otworu montażowego / CZ: rozmery montážního otvoru / SK: rozmery montážneho otvoru		GU5.3		PL: możliwość regulacji kierunku świecenia / CZ: světlo nastavitelné / SK: svetlo nastaviteľné
	PL: materiał / CZ: materiál / SK: materiál		PL: dedykowane źródło światła / CZ: určený zdroj světla / SK: určený svetelný zdroj		PL: czujnik ruchu / CZ: pohybové čidlo / SK: pohybové čidlo
	PL: uwagi / CZ: komentáře / SK: komentáře		SMD LED		PL: regulacja czujnika / CZ: nastavení snímača / SK: nastavení čidla
	PL: zdjęcie produktu / CZ: fotografie produktu / SK: fotografie produktu		COB LED		PL: czujnik zmierzchu / CZ: súmrakové čidlo / SK: soumrakové čidlo
	PL: kod Ideus / CZ: kód Ideus / SK: kód Ideus		POWER LED		PL: IP - stopień odporności na wnikanie ciał stałych i wilgoci / CZ: IP - stupeň krytí / SK: IP - stupeň krytia
	PL: nazwa produktu / CZ: název výrobku / SK: názov výrobku		COG LED		PL: do zastosowania wewnątrz / CZ: k vnitřnímu použití / SK: k vnútornému použitiu
	PL: kod kreskowy EAN / CZ: čárový kód EAN / SK: čiarový kód EAN		DIP LED		PL: do zastosowania na zewnątrz lub wewnątrz / CZ: k venkovnímu nebo vnitřnímu použití / SK: k vonkajšiemu alebo vnútornému použitiu
	PL: zasilanie / CZ: napájení / SK: napájanie		G9		PL: minimalna odległość od oświetlanego obiektu / CZ: minimalní vzdálenost od osvětlovaného předmětu / SK: minimálna vzdialenosť od osvetľovaného predmetu
	PL: moc / CZ: výkon / SK: výkon		JC		PL: klasa ochronności przed porażeniem elektrycznym / CZ: třída ochrany před úrazem elektrickým proudem / SK: rieda ochrany pred úrazom elektrickým prúdom
	PL: strumień świetlny / CZ: světelný tok / SK: svetelný tok		GU10		PL: pierwsza / CZ: první / SK: prvý
	PL: kolor / CZ: barva / SK: farba		MR16		PL: druga / CZ: druhá / SK: druhá
	PL: barwa światła / CZ: barva světla / SK: farba svetla		T5 / T8		PL: trzecia / CZ: třetí / SK: tretia
	PL: temperatura barwa Tc / CZ: teplota chromatičnosti Tc / SK: teplota chromatičnosti Tc		PL		CE
	PL: dopuszczalne odchylenie barwy / CZ: přípustná odchylka barvy / SK: přípustná odchylka farby		PL: świetłówka/LED / CZ: úsporná zářivka/LED / SK: úsporná žiarivka/LED		STRÜHM
	PL: rodzaj trzonka / CZ: patice / SK: päťca		PL: niewymienne źródło światła / CZ: nevyměnitelný světelný zdroj / SK: nevymeniteľný svetelný zdroj		HOROZ
	E14		PL: możliwość stosowania ze ściemniaczem / CZ: vhodné pro použití se stmívačem / SK: vhodné pre použitie so stmievačom		
	E27		PL: nie stosować ze ściemniaczem / CZ: nepoužívejte stmívače / SK: nepoužívajte stmievača		
	G4		PL: kąt rozsyłu światłości / CZ: vyzařovací úhel / SK: vyžarovací uhol		
	G9		PL: współczynnik oddawania barw Ra / CZ: index reprodukce barev Ra / SK: Index reprodukcie farieb Ra		
	G5		PL: trwałość źródła światła / CZ: životnost světelného zdroje / SK: životnosť svetelného zdroja		
	G13				
	G23				

## Karta katalogowa

**cz:** Katalógový list / **sk:** Katalógový list

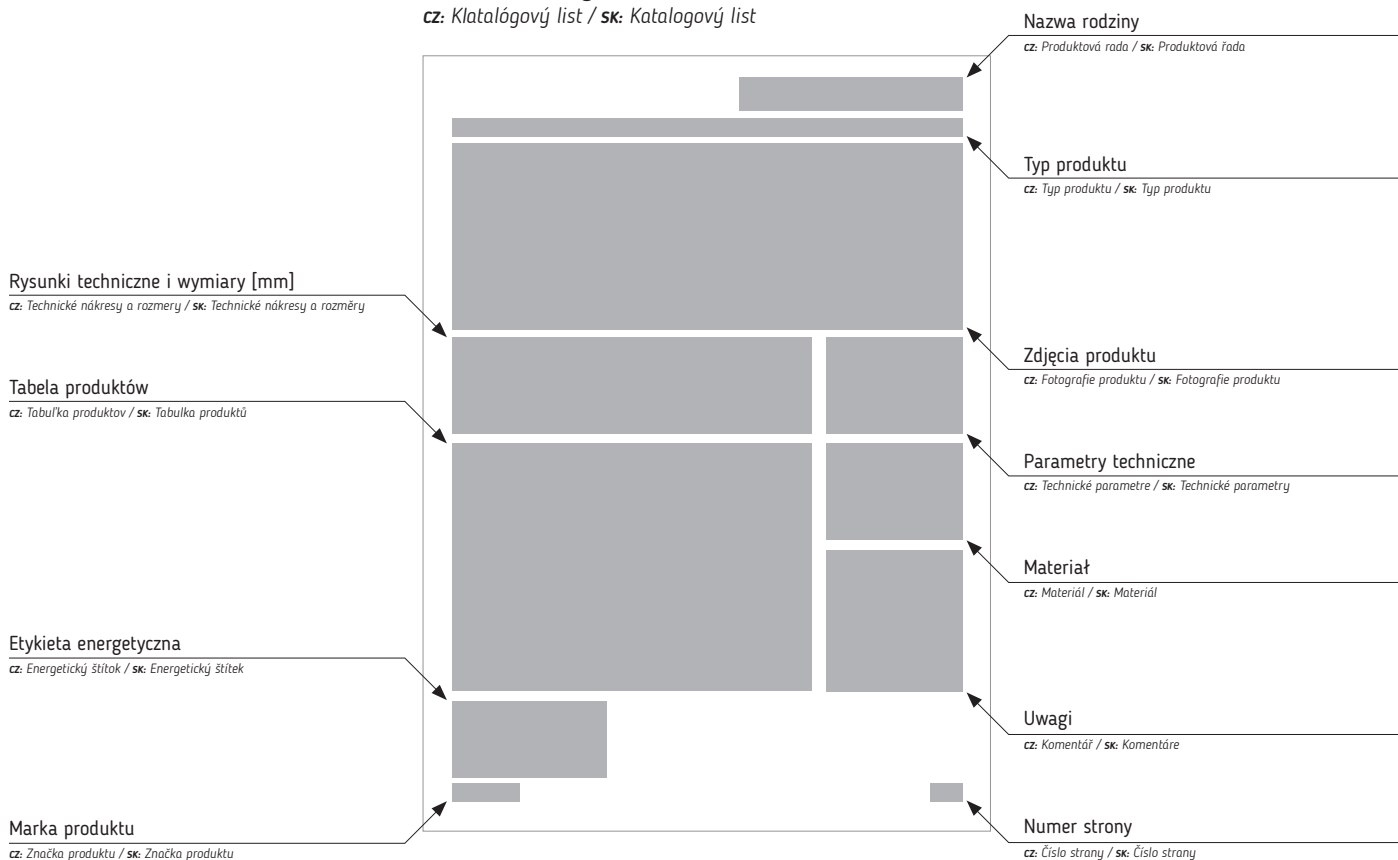



Dane rejestrowe / Registrační údaje / Registračné údaje:

Ideus Sp. z o.o.  
ul. Bolesława Chrobrego 26/114  
40-881 Katowice, Polska  
NIP: 6342790540

Biuro handlowe / Kancelář / Kancelária

IDEUS Sp. z o.o.  
ul. Niedźwiedziniec 10  
41-506 Chorzów, Polska  
Prologis Park, budynek DC4

tel. +48 32 750 03 08  
fax +48 32 750 03 87  
e-mail: [ideus@ideus.pl](mailto:ideus@ideus.pl)

[www.ideus.pl](http://www.ideus.pl)

